

File : D:\DATA\Aldrich\JA-09\JA021209-2.D
Operator : Aldrich
Acquired : 12 Feb 2009 15:15 using AcqMethod JA-WAX08.M
Instrument : Instrument #1
Sample Name: 7 14-22-d-old male C.oc. abd. /5ulCH2Cl2
Misc Info : larvae reared on aphids; different appearance
Vial Number: 1

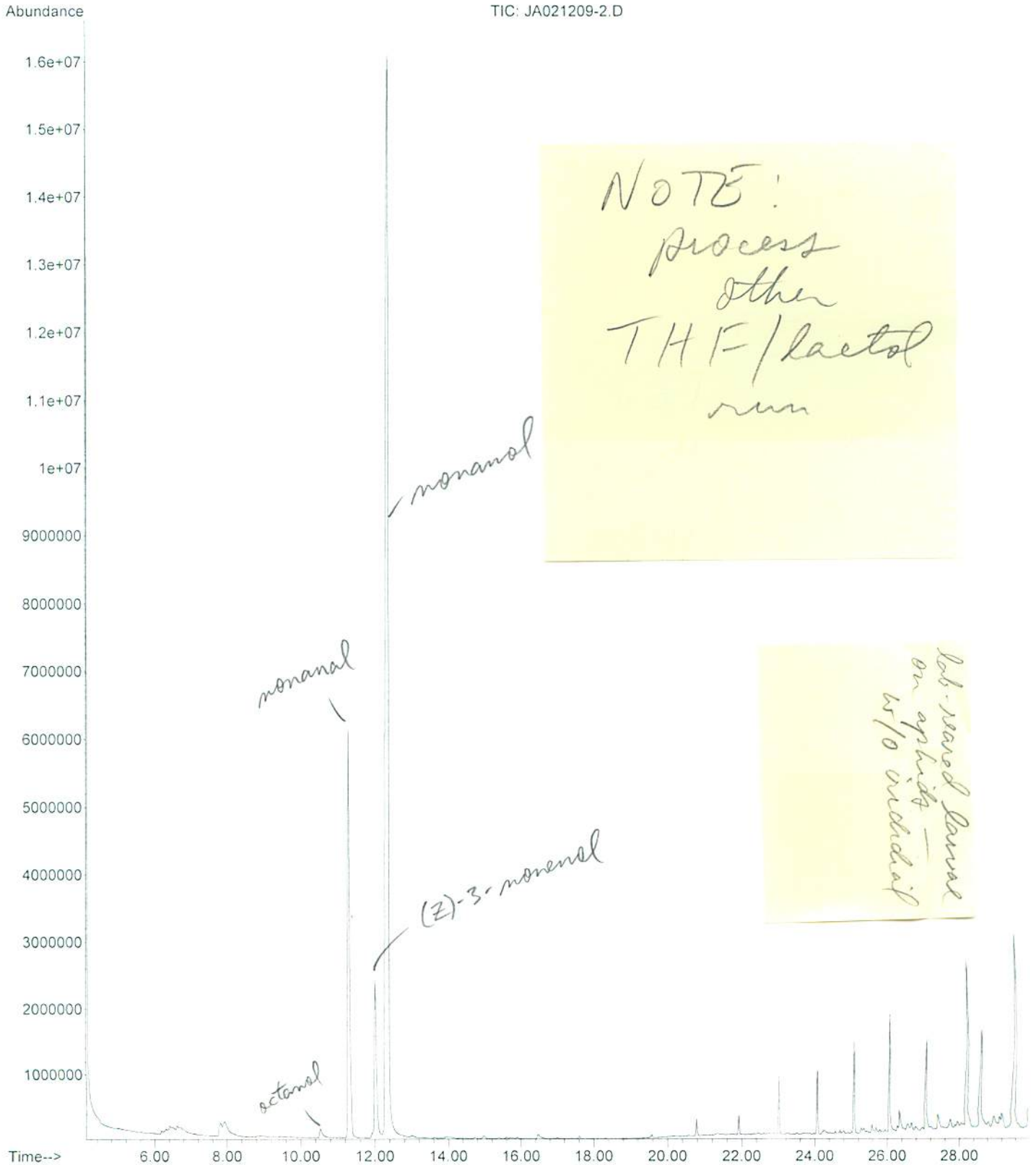

File : D:\DATA\ALDRICH\JA-09\Snapshot\JA021209-2.D
Operator : Aldrich
Acquired : 12 Feb 2009 15:15 using AcqMethod JA-WAX08.M
Instrument : Instrument #1
Sample Name: 7 14-22-d-old male C.oc. abd. /5ulCH2Cl2
Misc Info : larvae reared on aphids; different appearance
Vial Number: 1

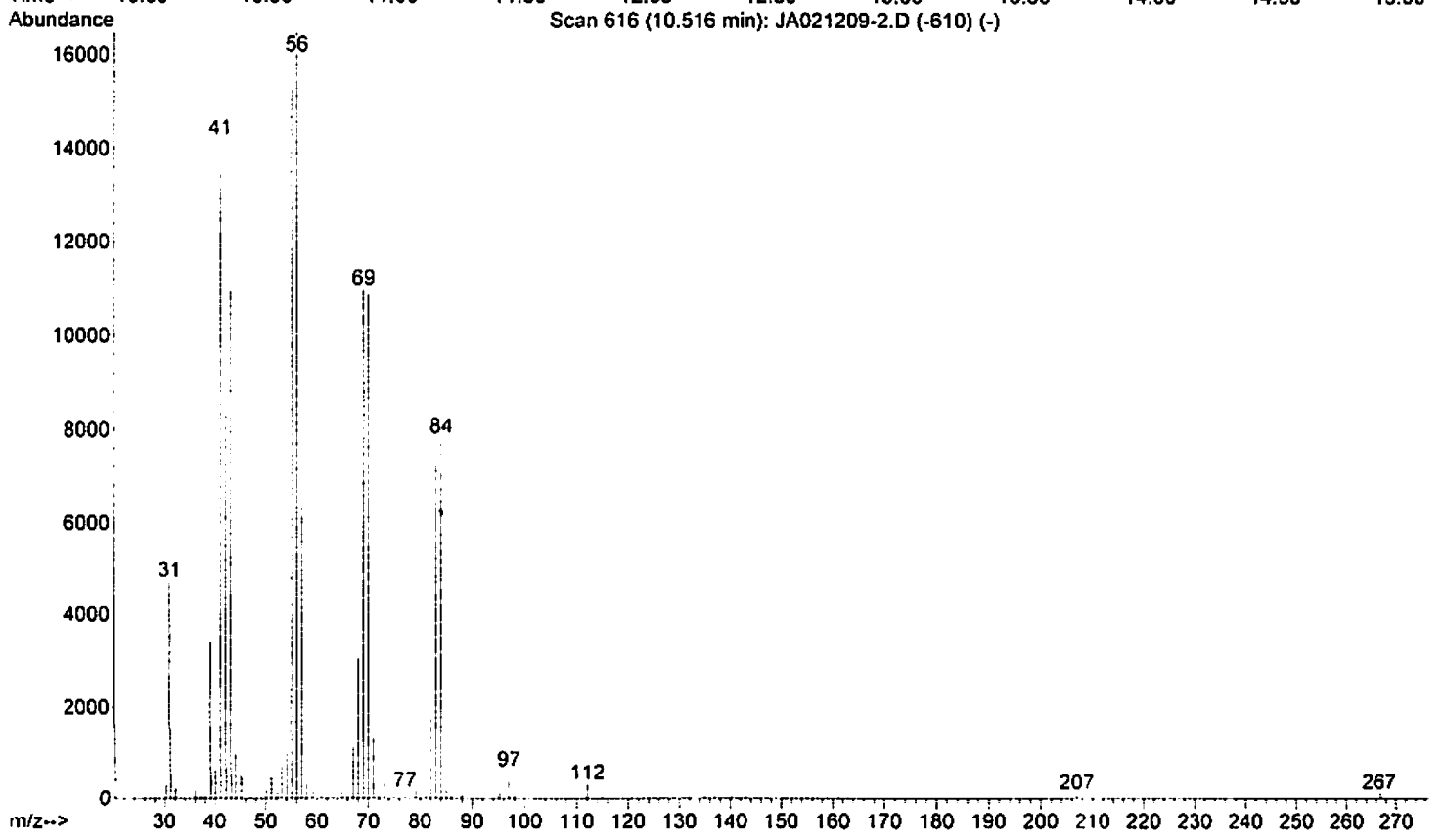

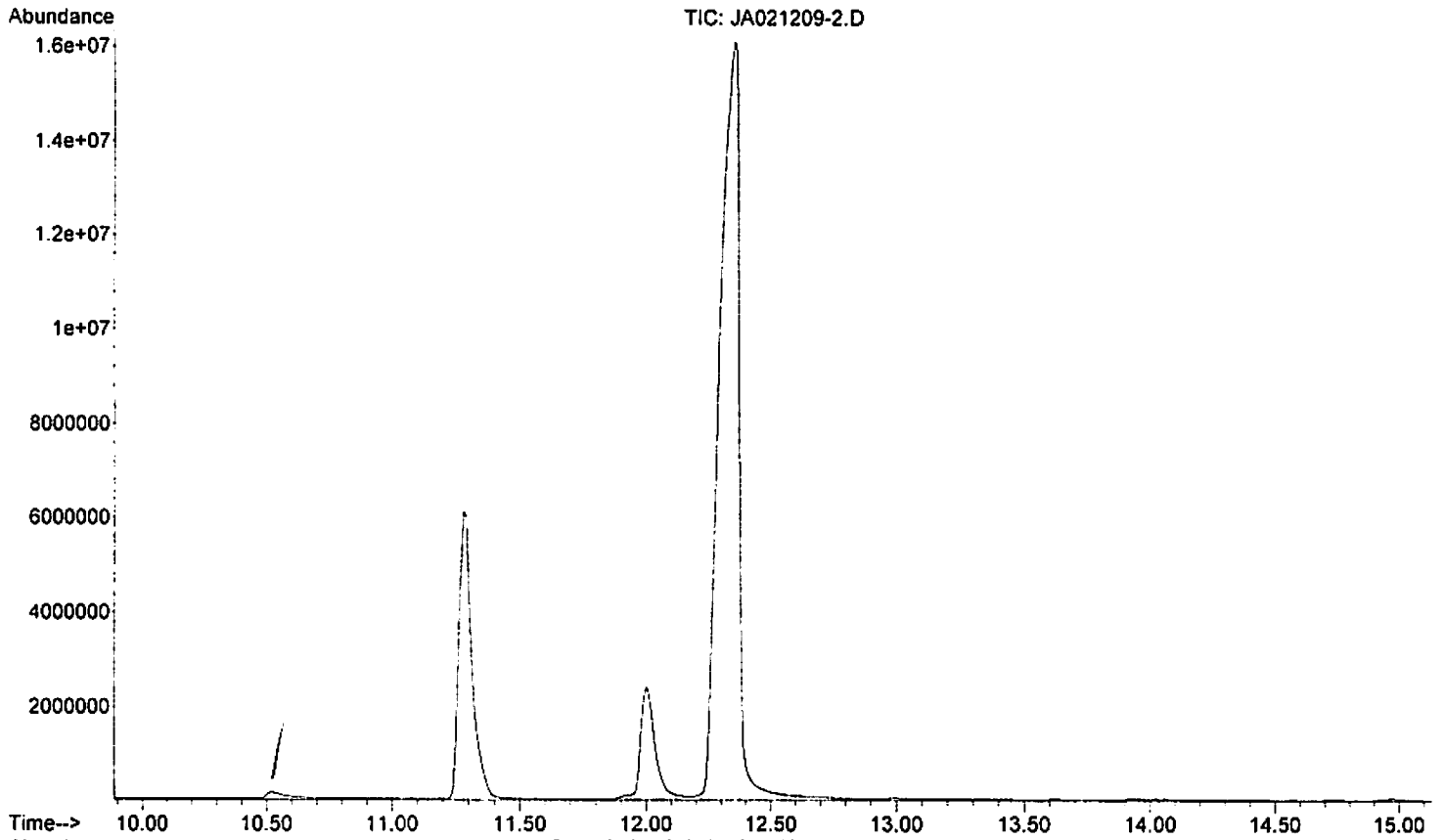
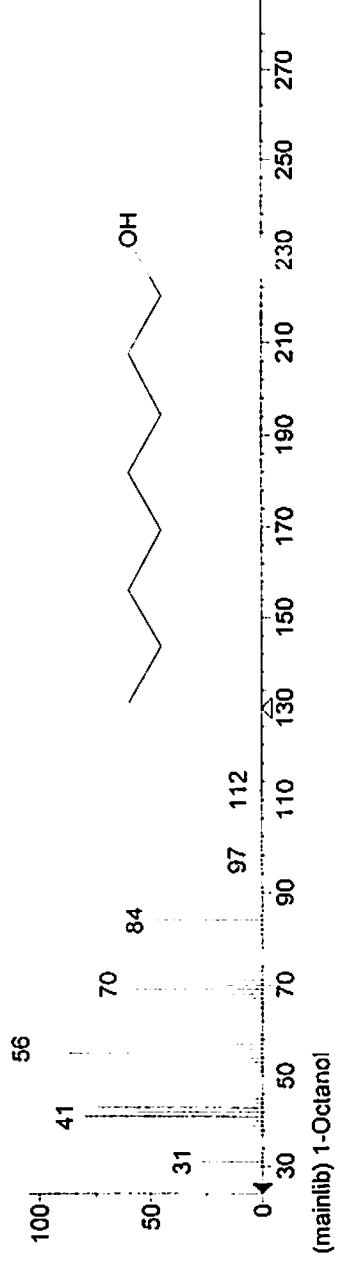
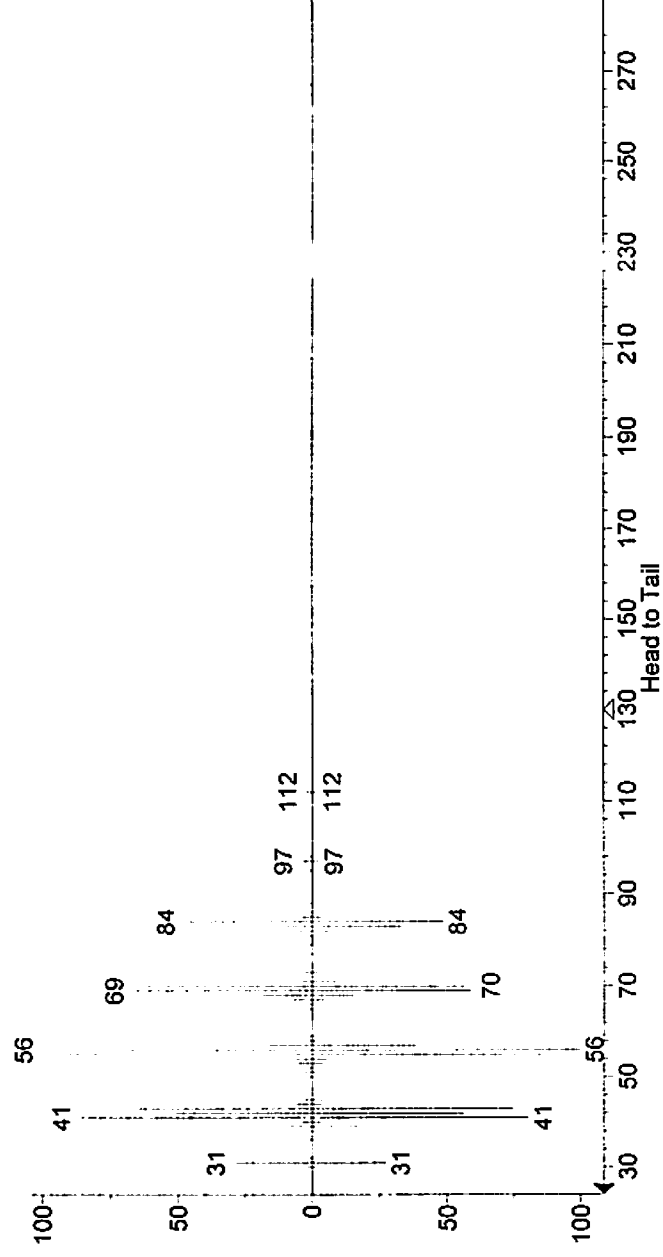
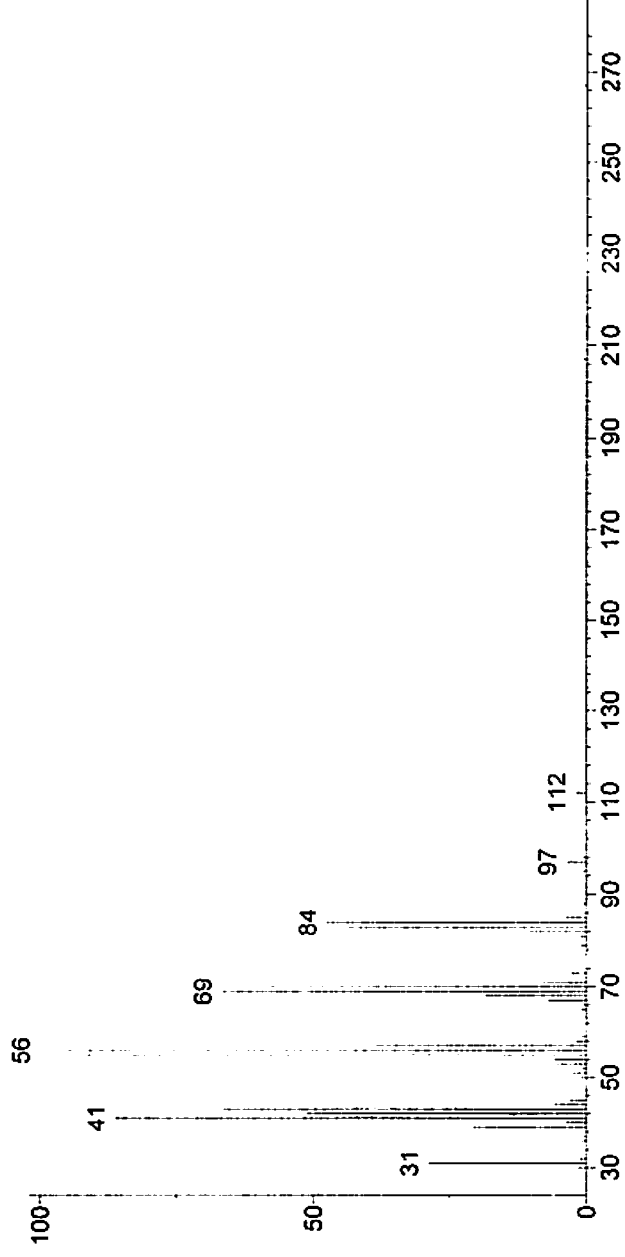

File : D:\DATA\ALDRICH\JA-09\Snapshot\JA021209-2.D
Operator : Aldrich
Acquired : 12 Feb 2009 15:15 using AcqMethod JA-WAX08.M
Instrument : Instrument #1
Sample Name: 7 14-22-d-old male C.oc. abd. /5ulCH2C12
Vial Info : larvae reared on aphids; different appearance
Vial Number: 1

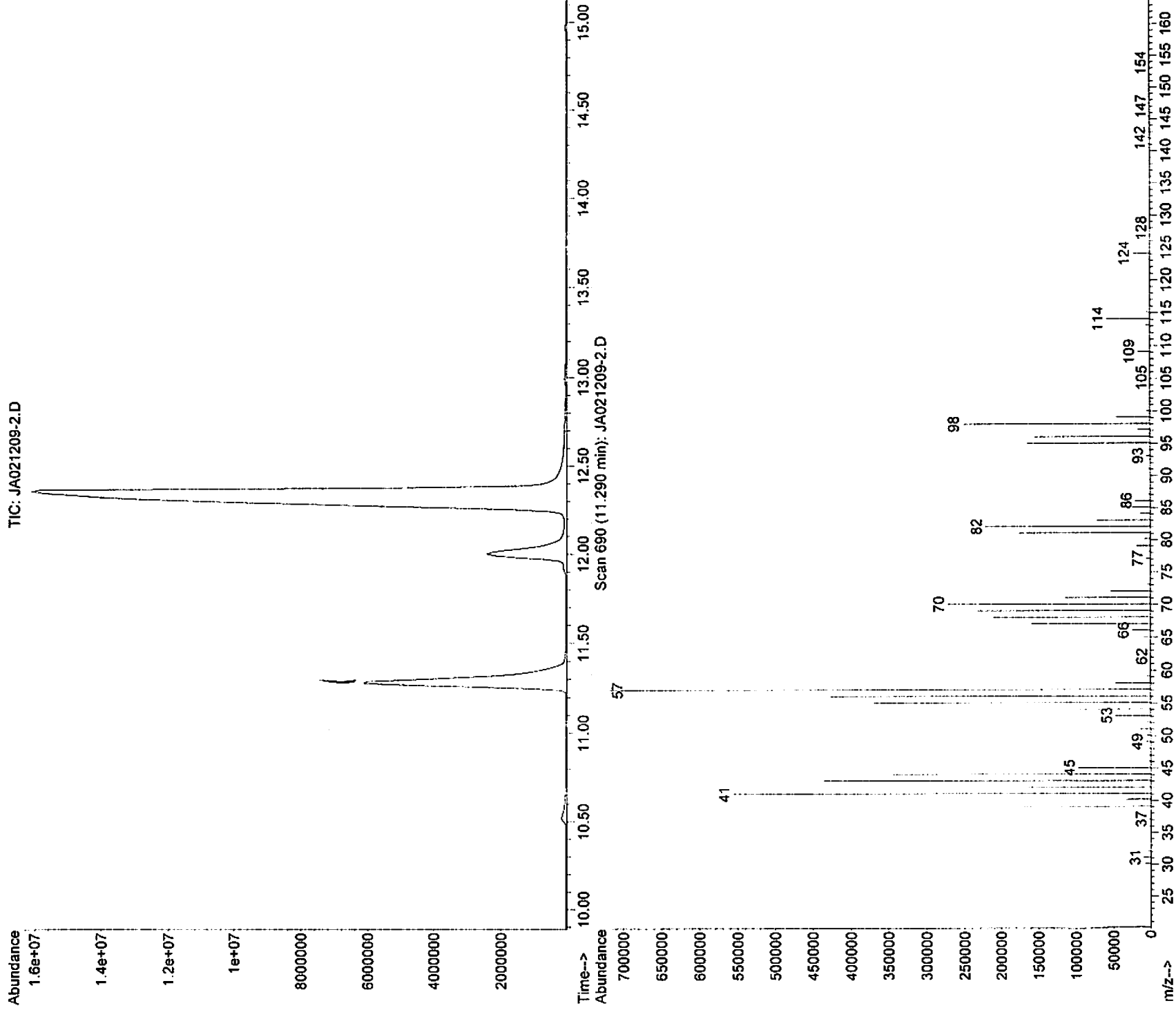

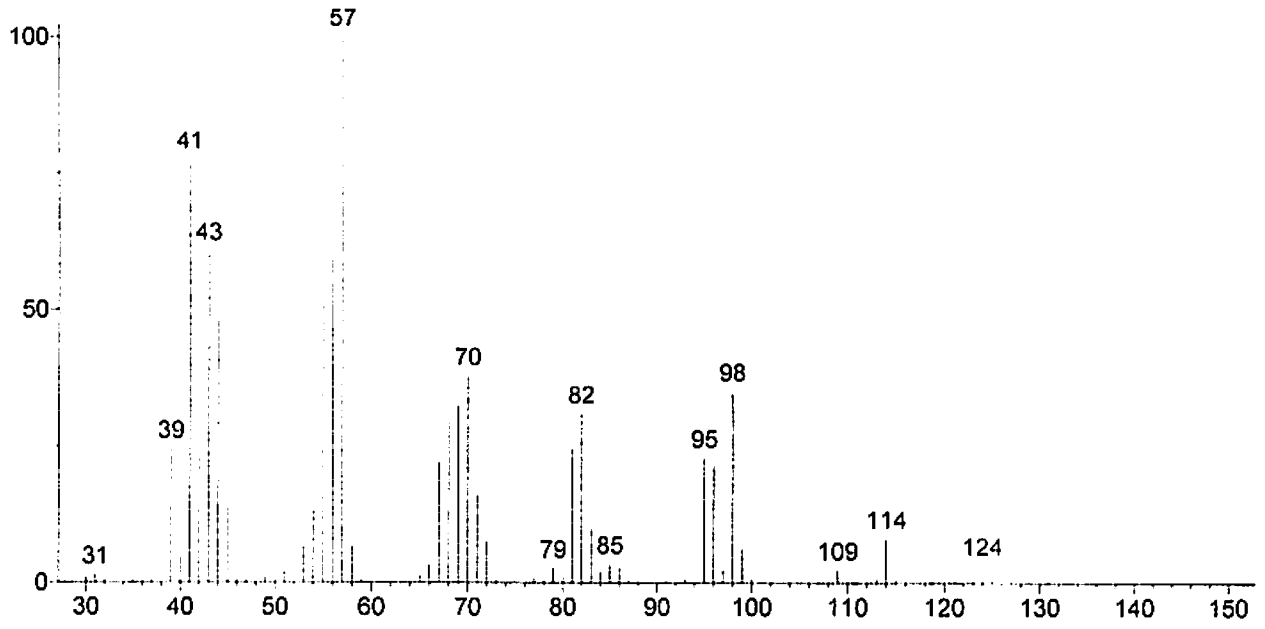

(Text File) Scan 690 (11.290 min): JA021209-2.D

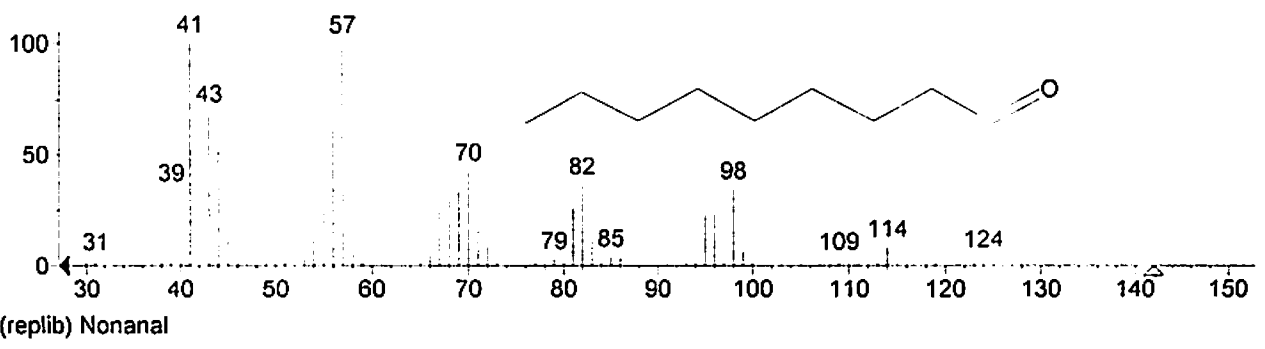
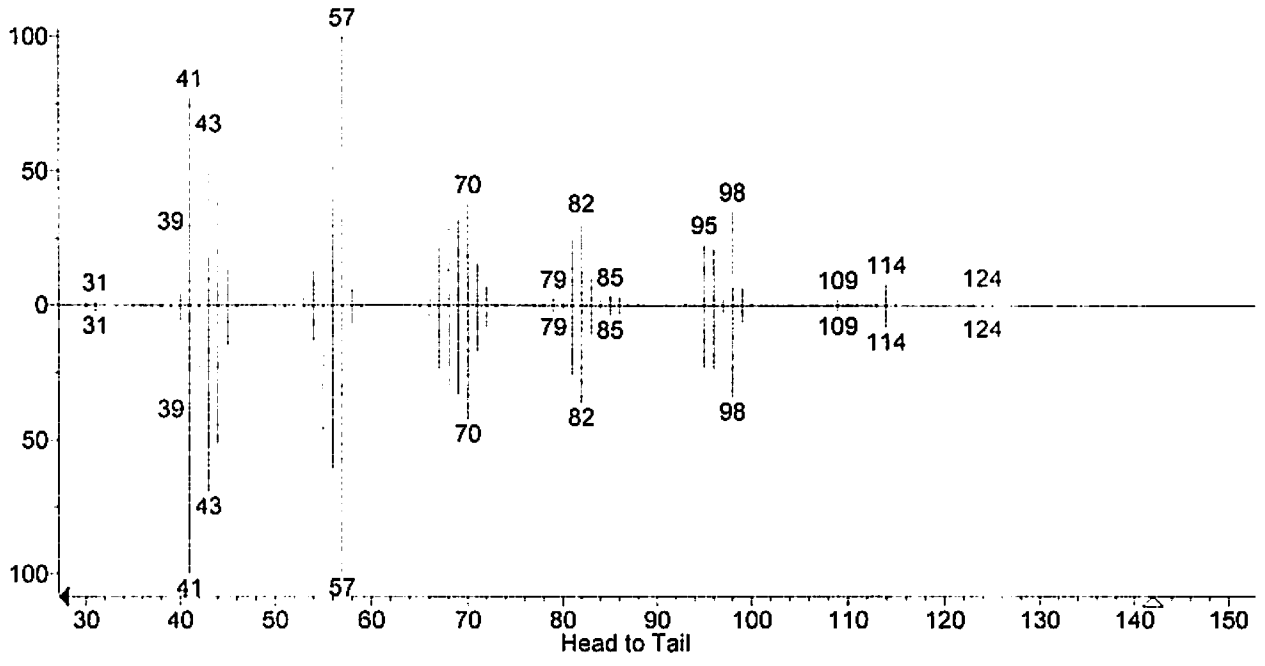

(replib) Nonanal

File : D:\DATA\ALDRICH\JA-09\Snapshot\JA021209-2.D
Operator : Aldrich
Acquired : 12 Feb 2009 15:15 using AcqMethod JA-WAX08.M
Instrument : Instrument #1
Sample Name: 7 14-22-d-old male C.oc. abd. /5ulCH2Cl2
Misc Info : larvae reared on aphids; different appearance
Vial Number: 1

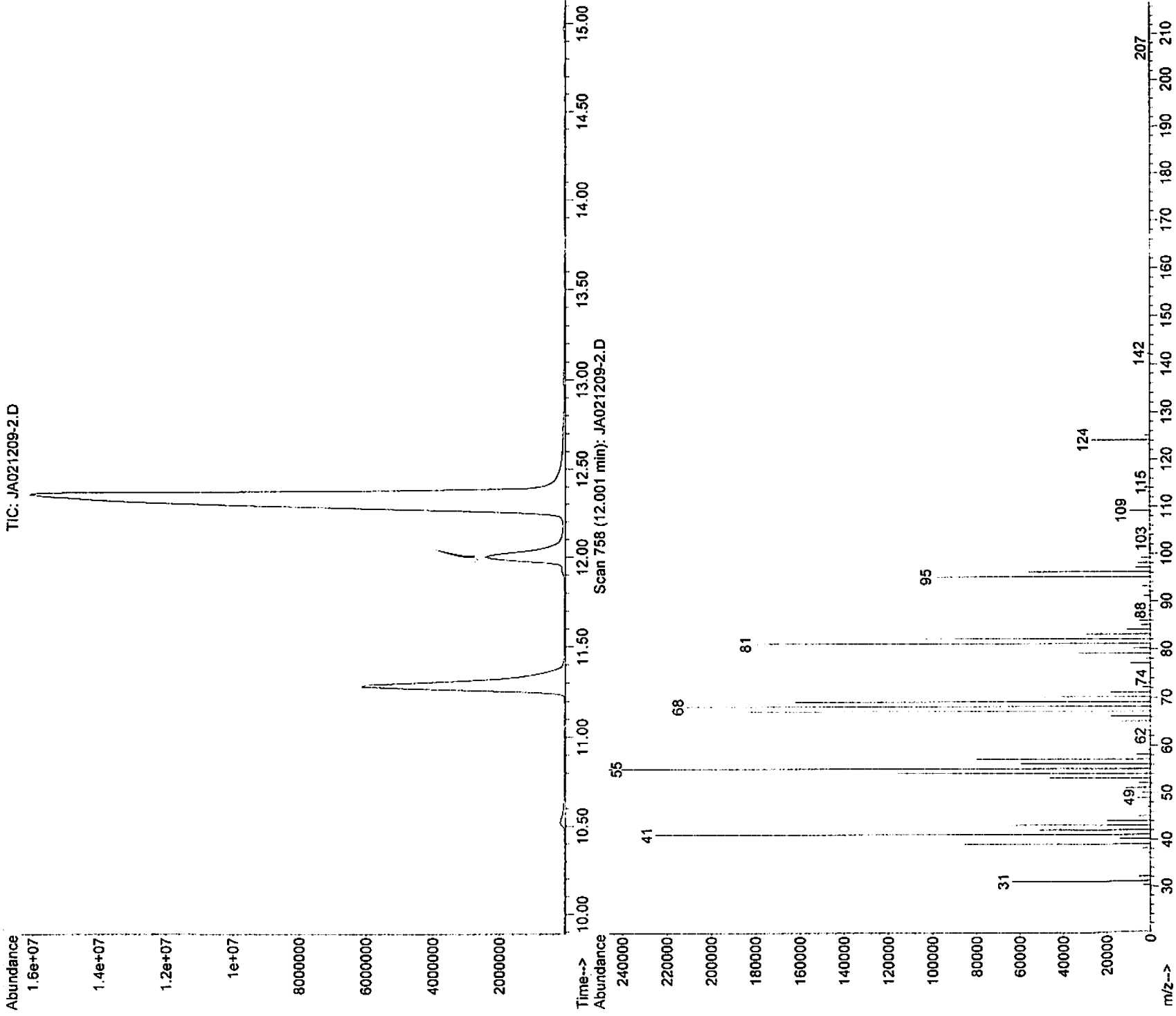

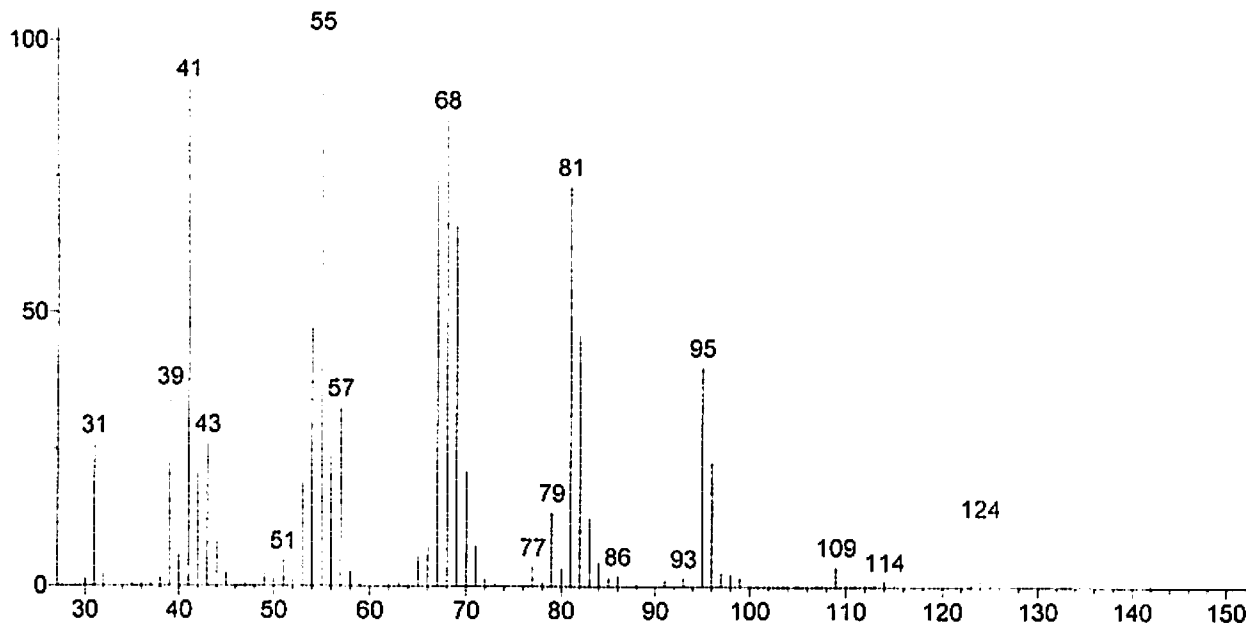

(Text File) Scan 758 (12.001 min): JA021209-2.D

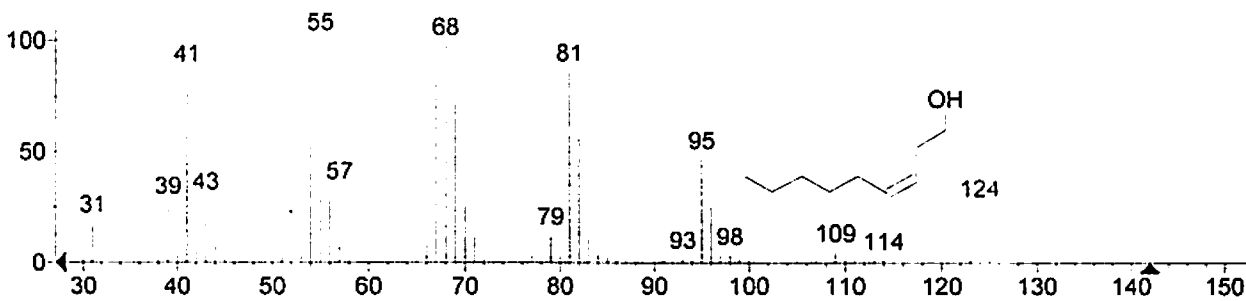
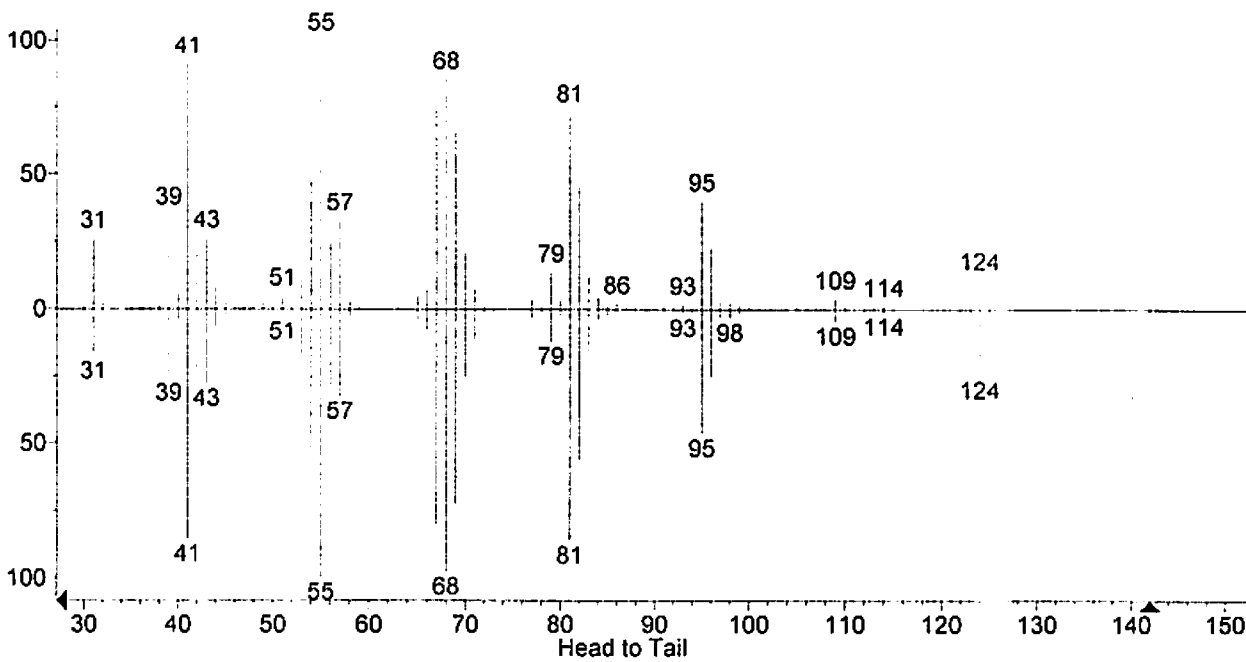

(mainlib) 3-Nonen-1-ol, (Z)-

File : D:\DATA\ALDRICH\JA-09\Snapshot\JA021209-2.D
Operator : Aldrich
Acquired : 12 Feb 2009 15:15 using AcqMethod JA-WAX08.M
Instrument : Instrument #1
Sample Name: 7 14-22-d-old male C.oc. abd. /5ulCH2Cl2
Misc Info : larvae reared on aphids; different appearance
Vial Number: 1

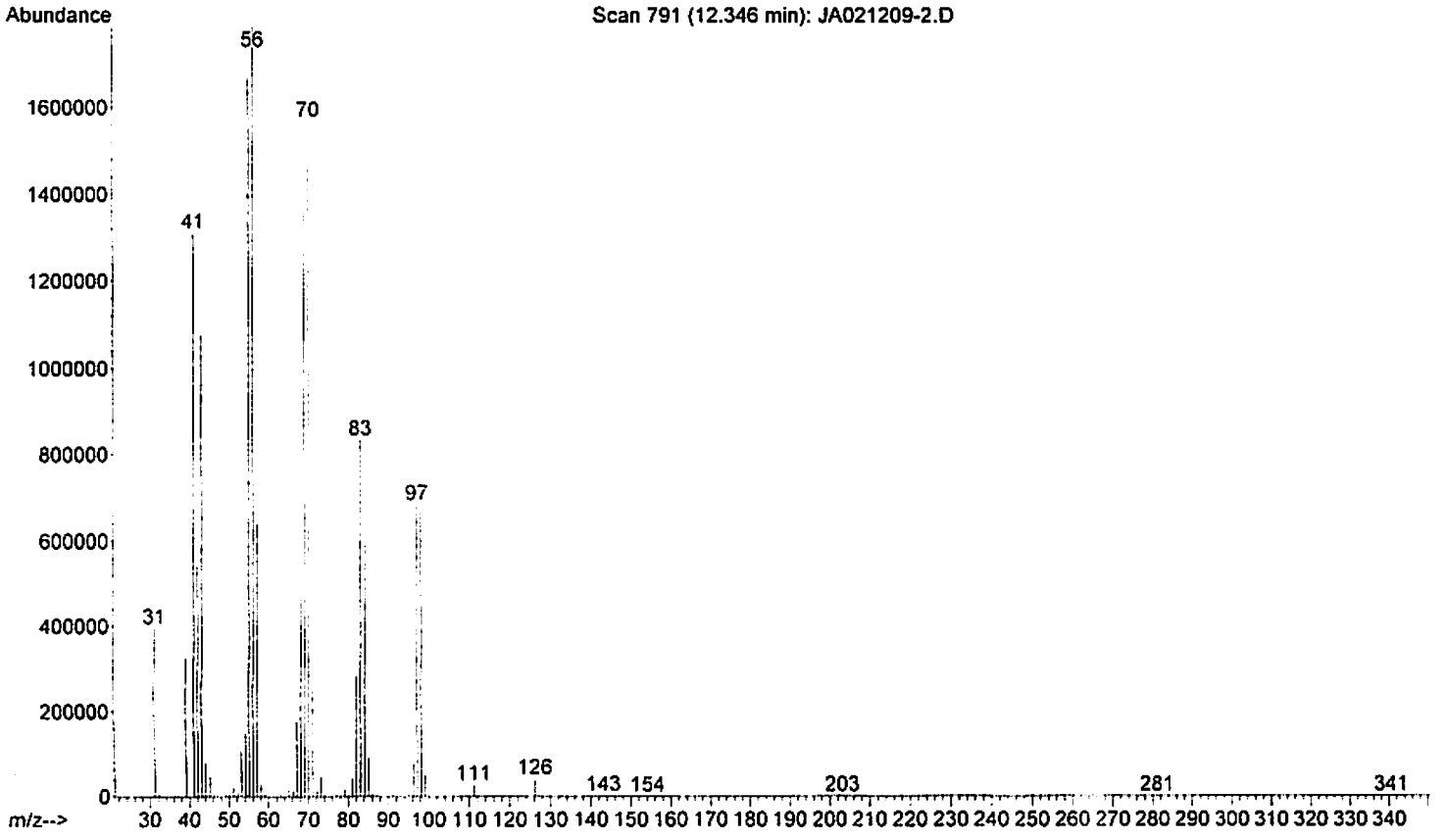
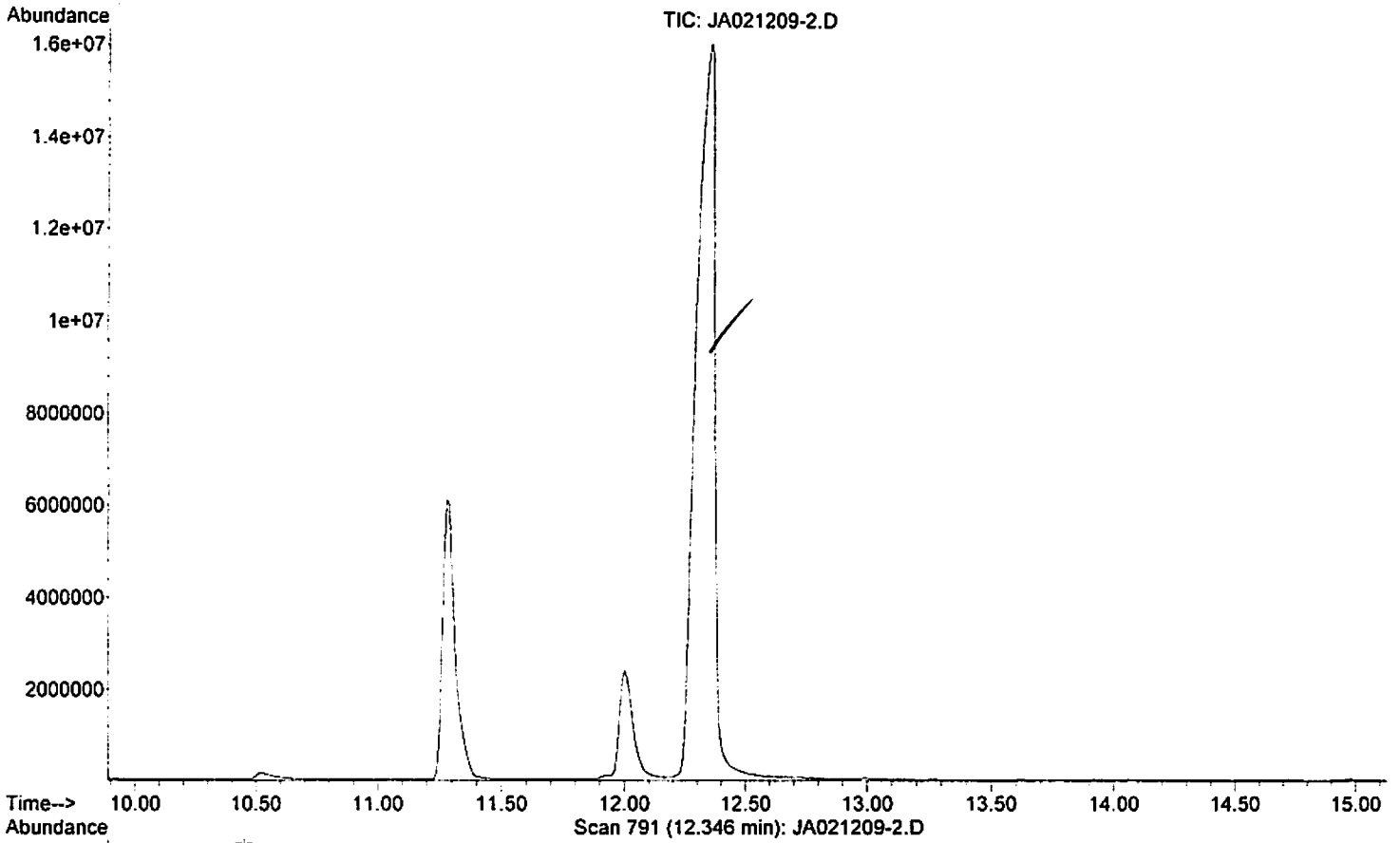

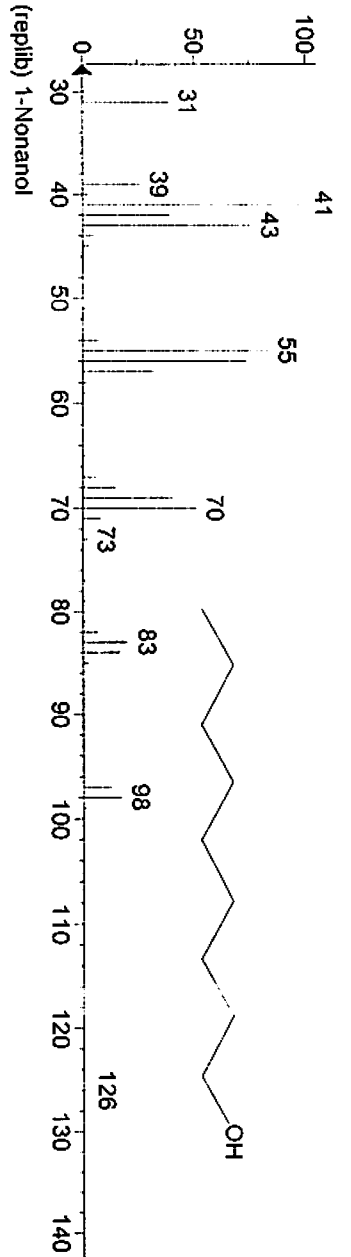
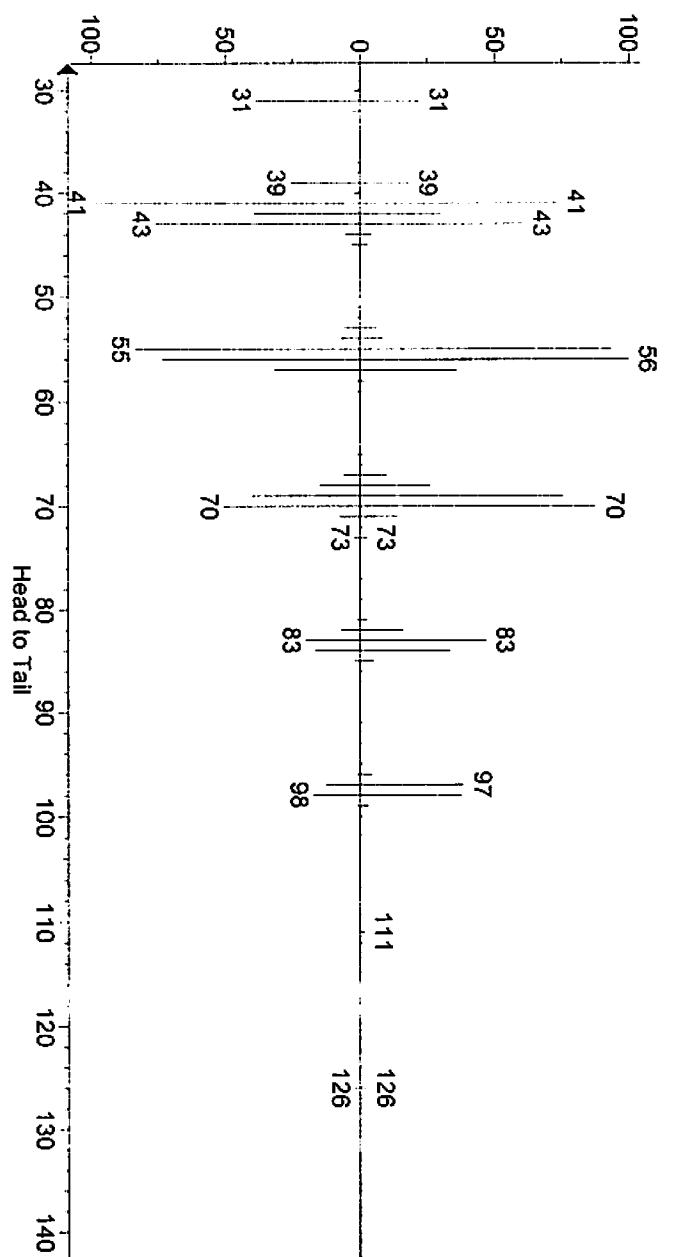
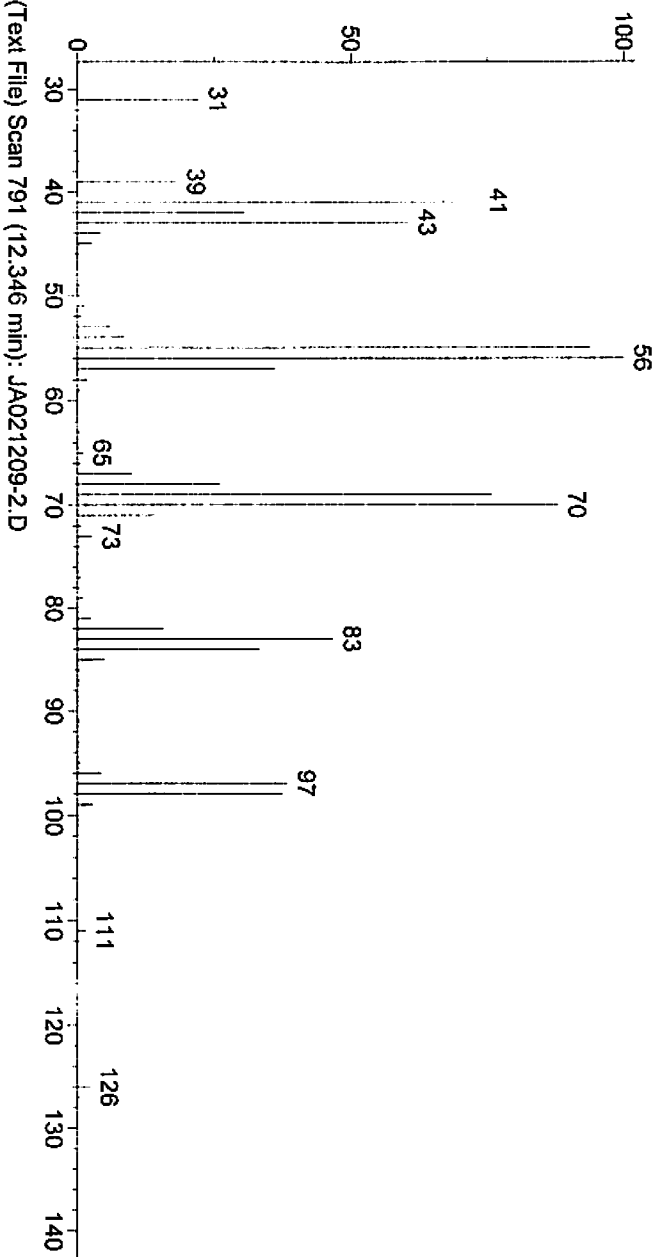

File : D:\DATA\Aldrich\JA-09\JA021209-2.D
Operator : Aldrich
Acquired : 12 Feb 2009 15:15 using AcqMethod JA-WAX08.M
Instrument : Instrument #1
Sample Name: 7 14-22-d-old male C.oc. abd. /5ulCH2Cl2
Misc Info : larvae reared on aphids; different appearance
Vial Number: 1

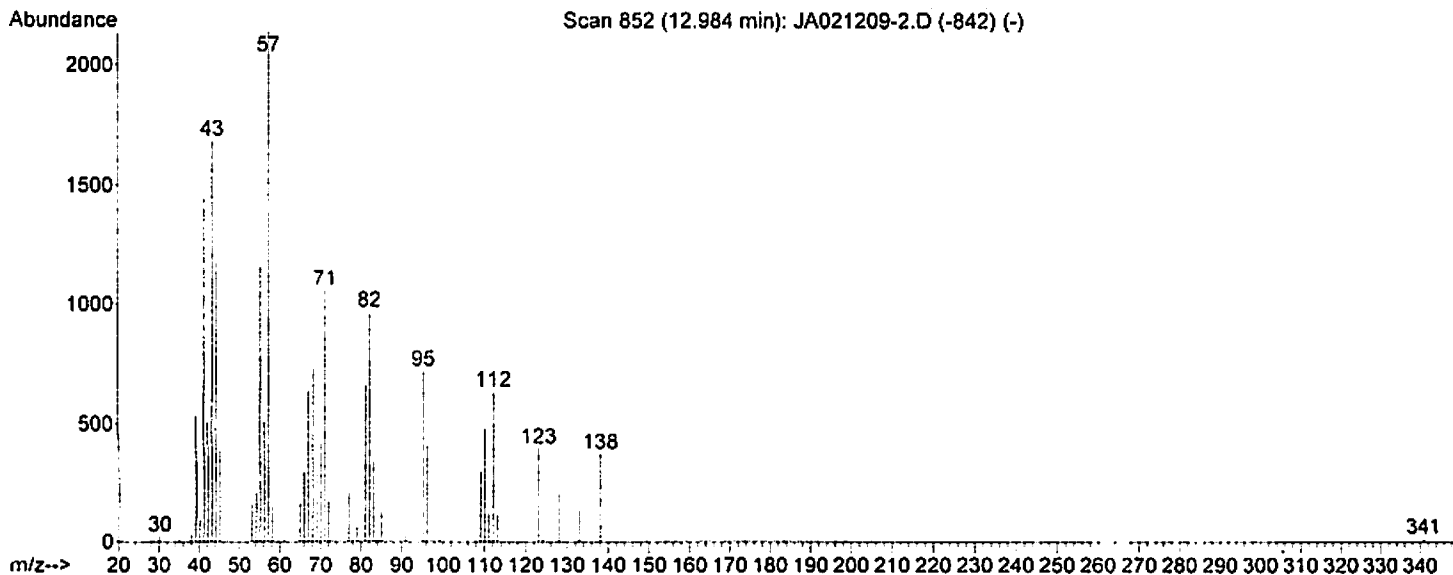
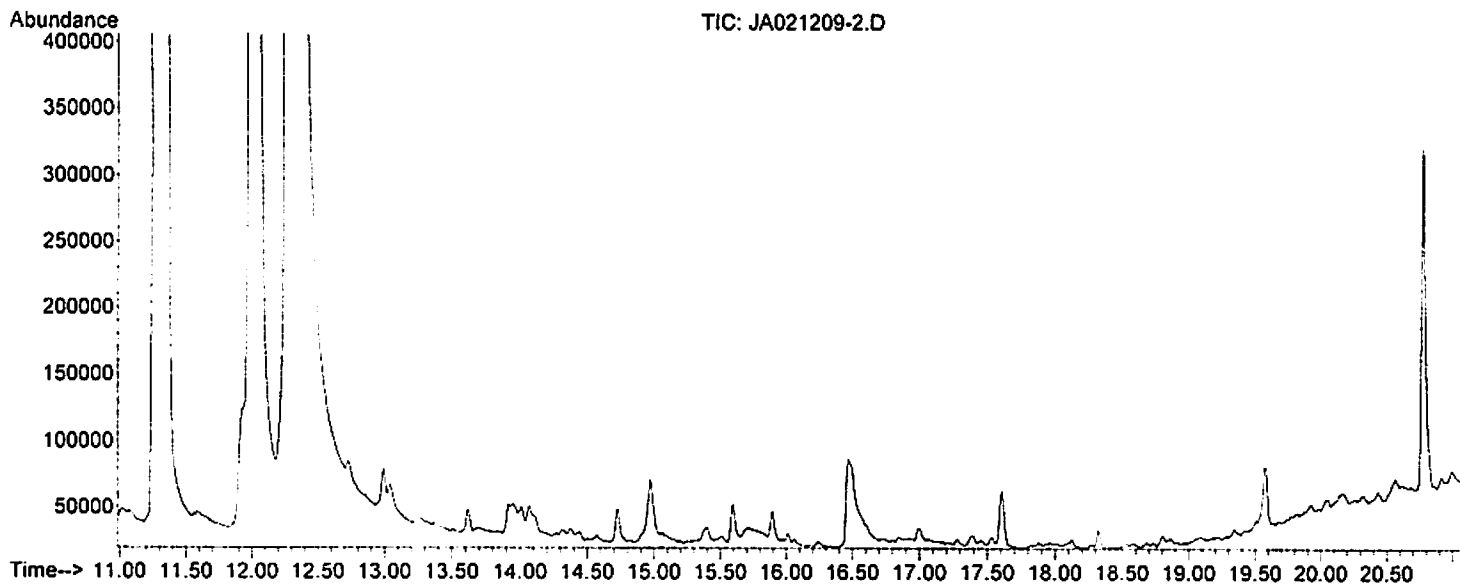

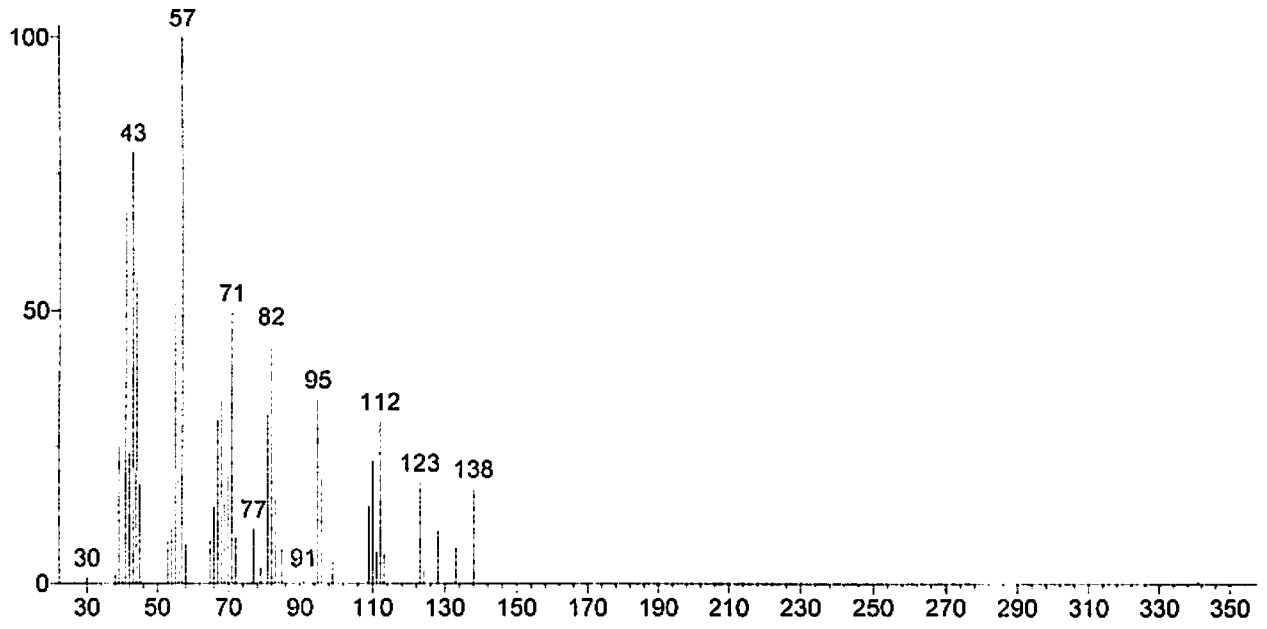

(Text File) Scan 852 (12.984 min): JA021209-2.D (-842)

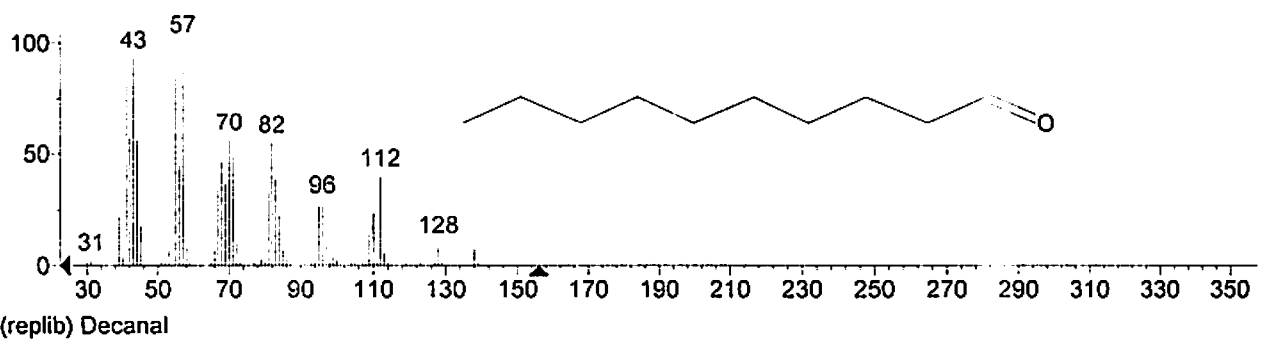
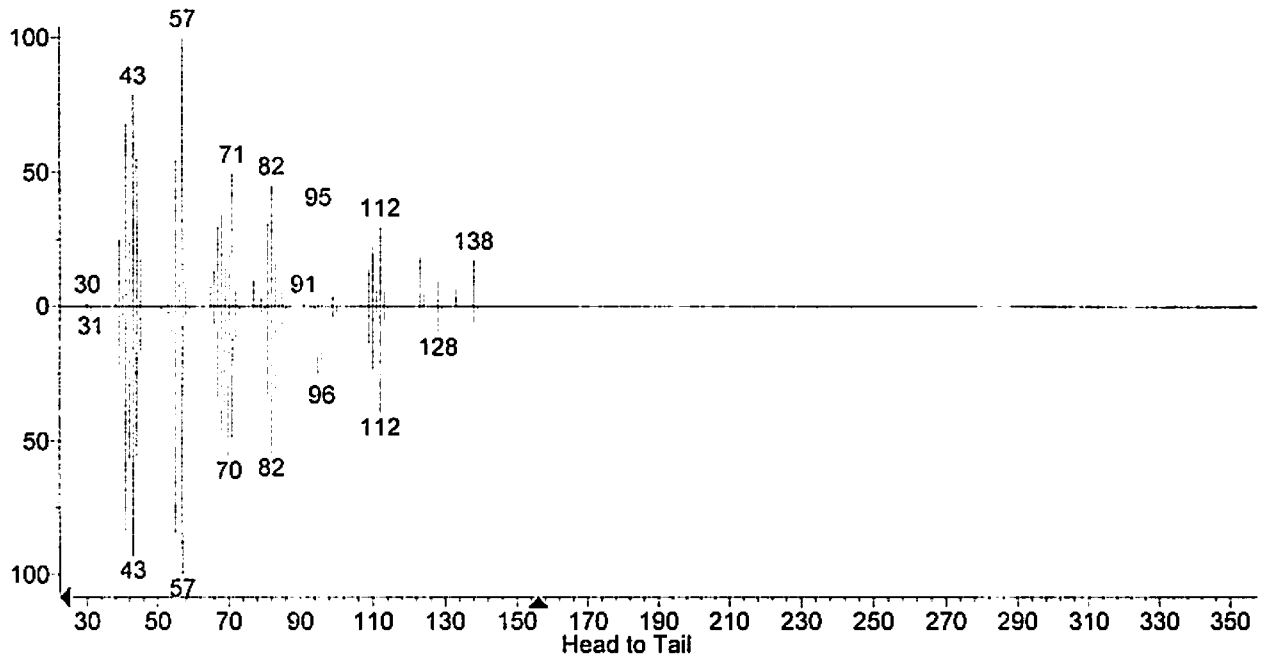

File : :D:\DATA\Aldrich\JA-09\JA021209-2.D
Operator : Aldrich
Acquired : 12 Feb 2009 15:15 using AcqMethod JA-WAX08.M
Instrument : Instrument #1
Sample Name: 7 14-22-d-old male C.oc. abd. /5ulCH2C12
Misc Info : larvae reared on aphids; different appearance
Vial Number: 1

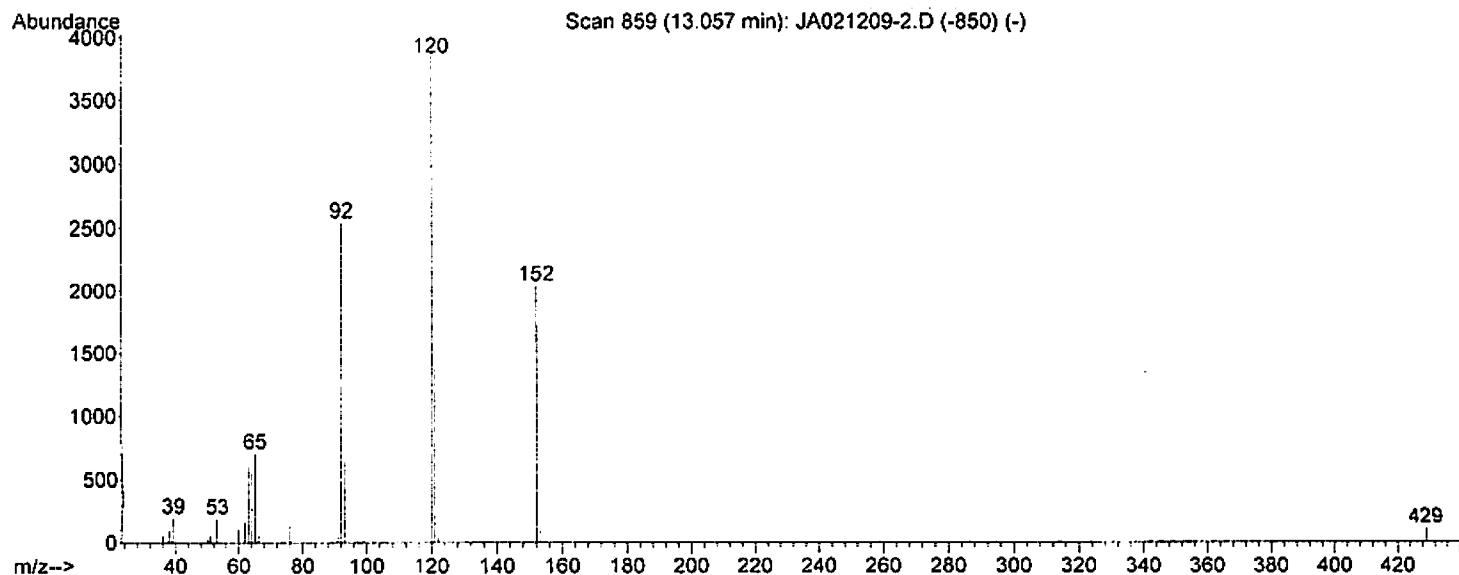
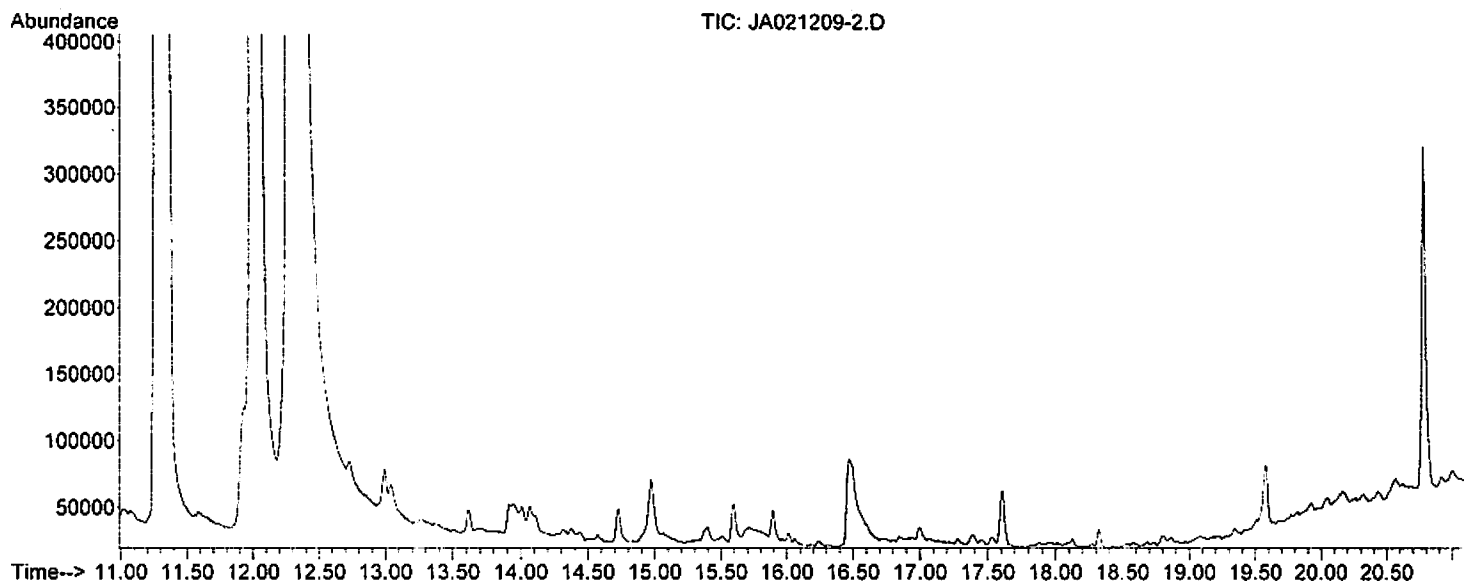

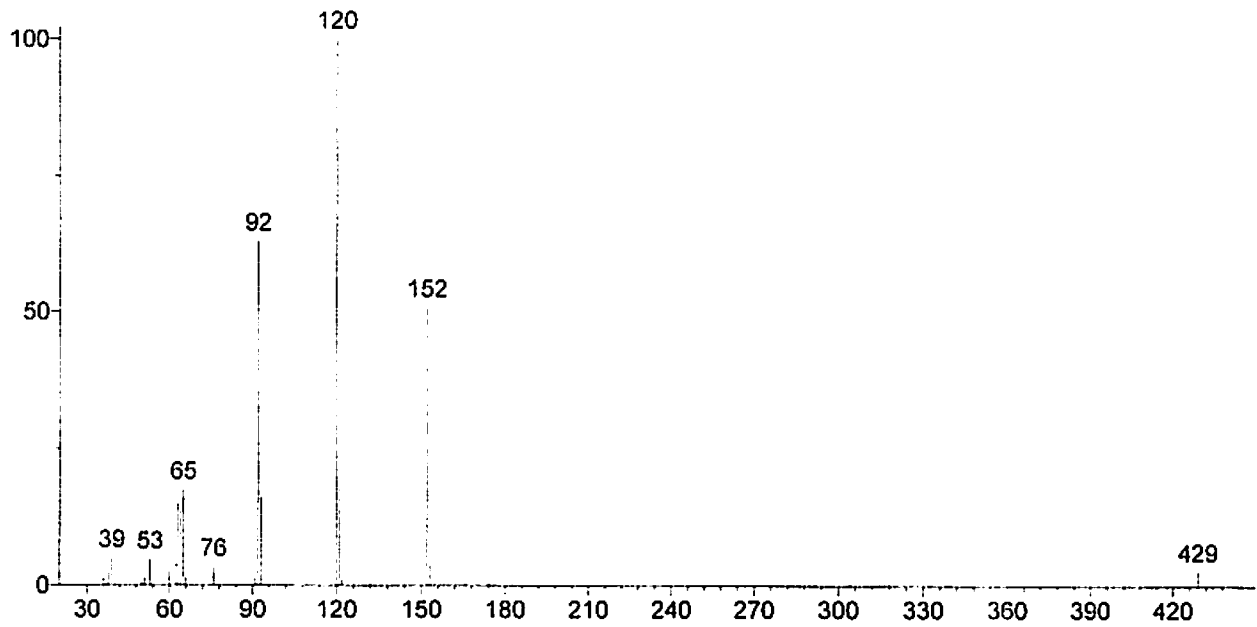

(Text File) Scan 859 (13.057 min): JA021209-2.D (-850)

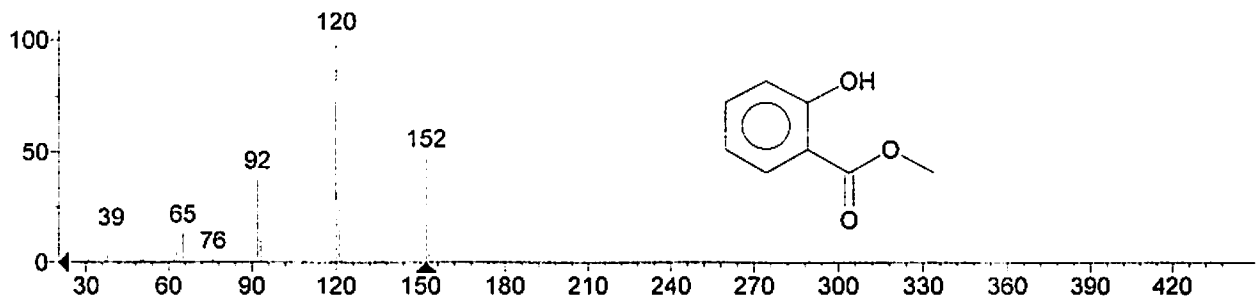
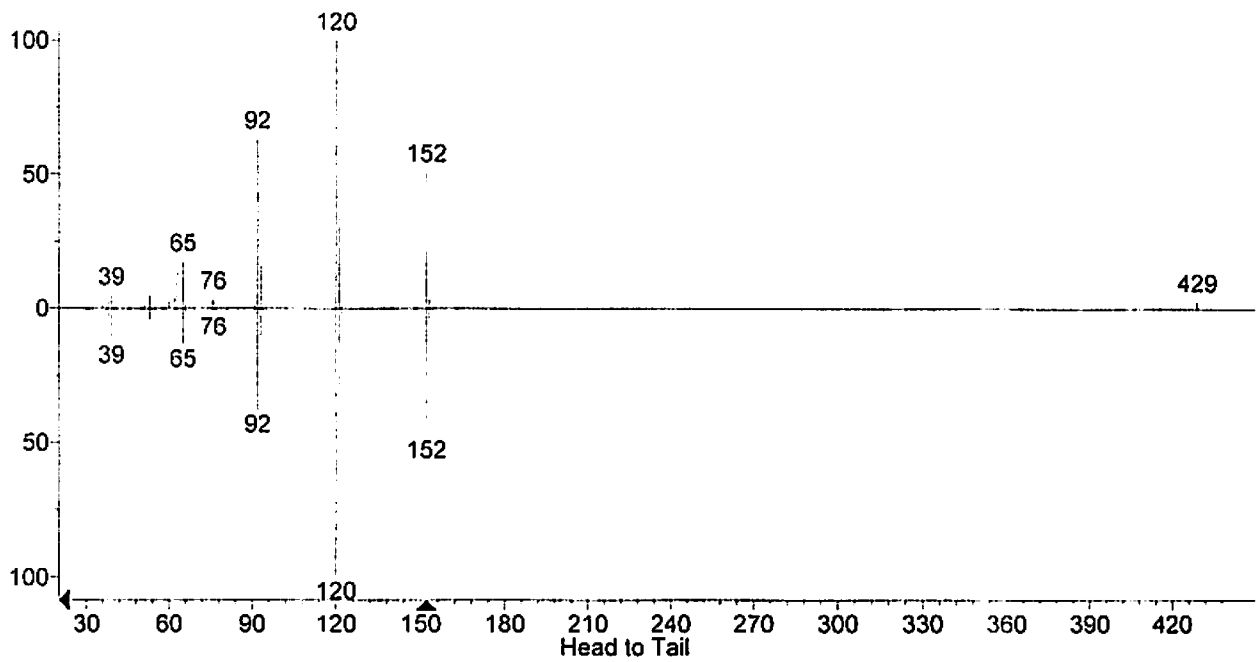

(replib) Methyl Salicylate

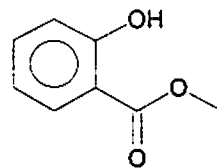

File : D:\DATA\Aldrich\JA-09\JA021209-2.D
Operator : Aldrich
Acquired : 12 Feb 2009 15:15 using AcqMethod JA-WAX08.M
Instrument : Instrument #1
Sample Name: 7 14-22-d-old male C.oc. abd. /5ulCH2Cl2
Misc Info : larvae reared on aphids; different appearance
Vial Number: 1

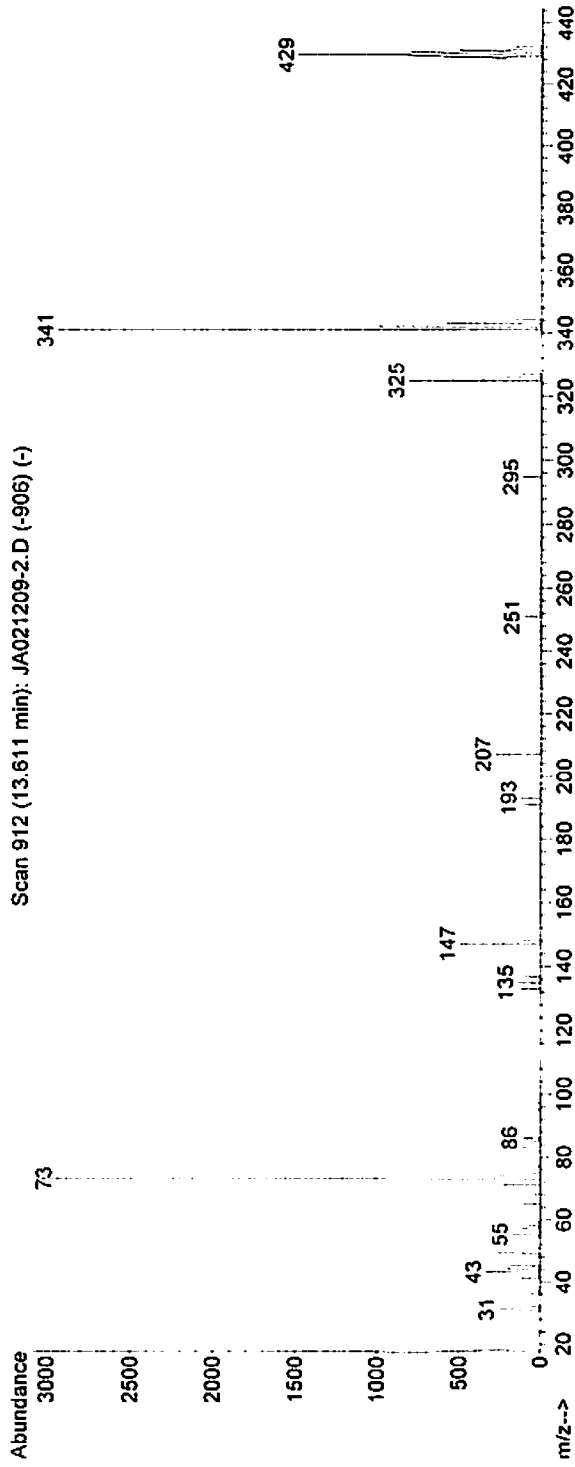
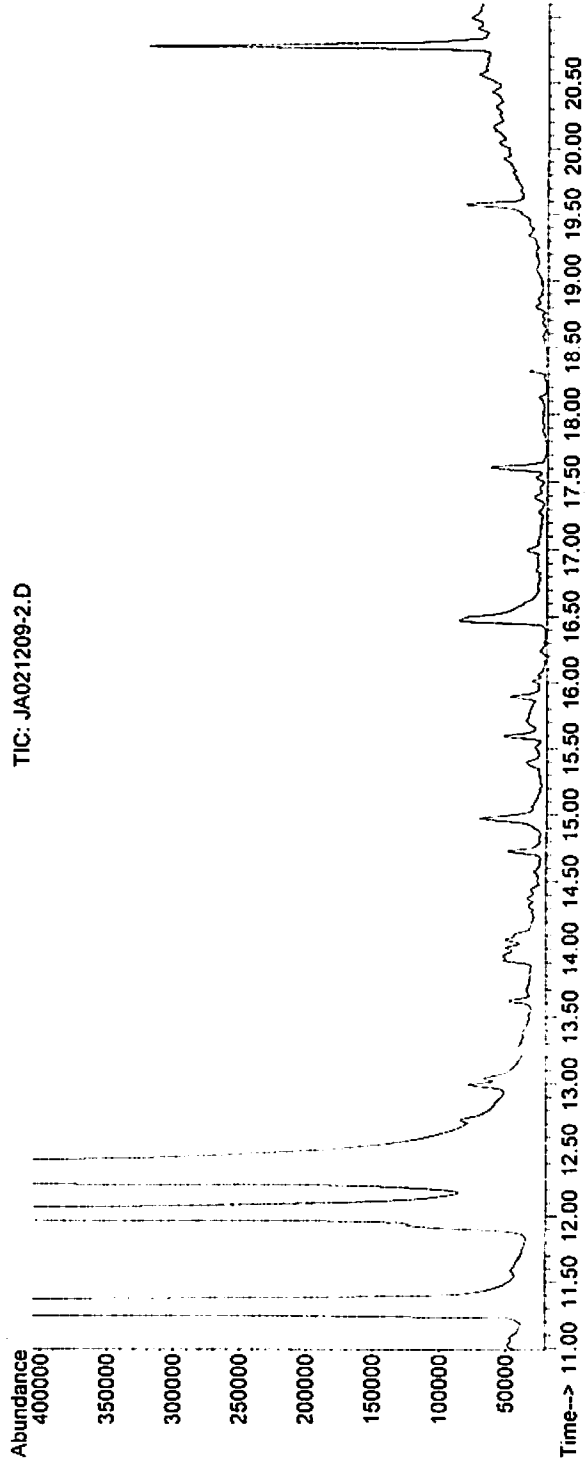

File : D:\DATA\Aldrich\JA-09\JA021209-2.D
Operator : Aldrich
Acquired : 12 Feb 2009 15:15 using AcqMethod JA-WAX08.M
Instrument : Instrument #1
Sample Name: 7 14-22-d-old male C.oc. abd. /5ulCH2Cl2
Misc Info : larvae reared on aphids; different appearance
Vial Number: 1

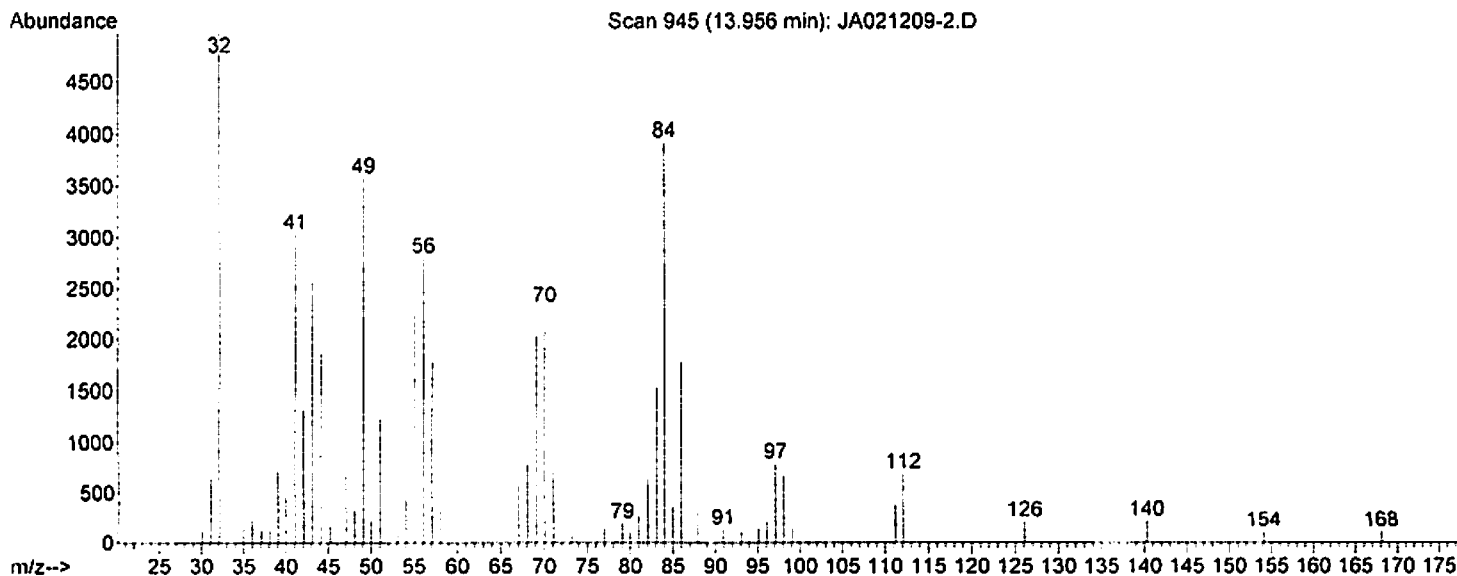
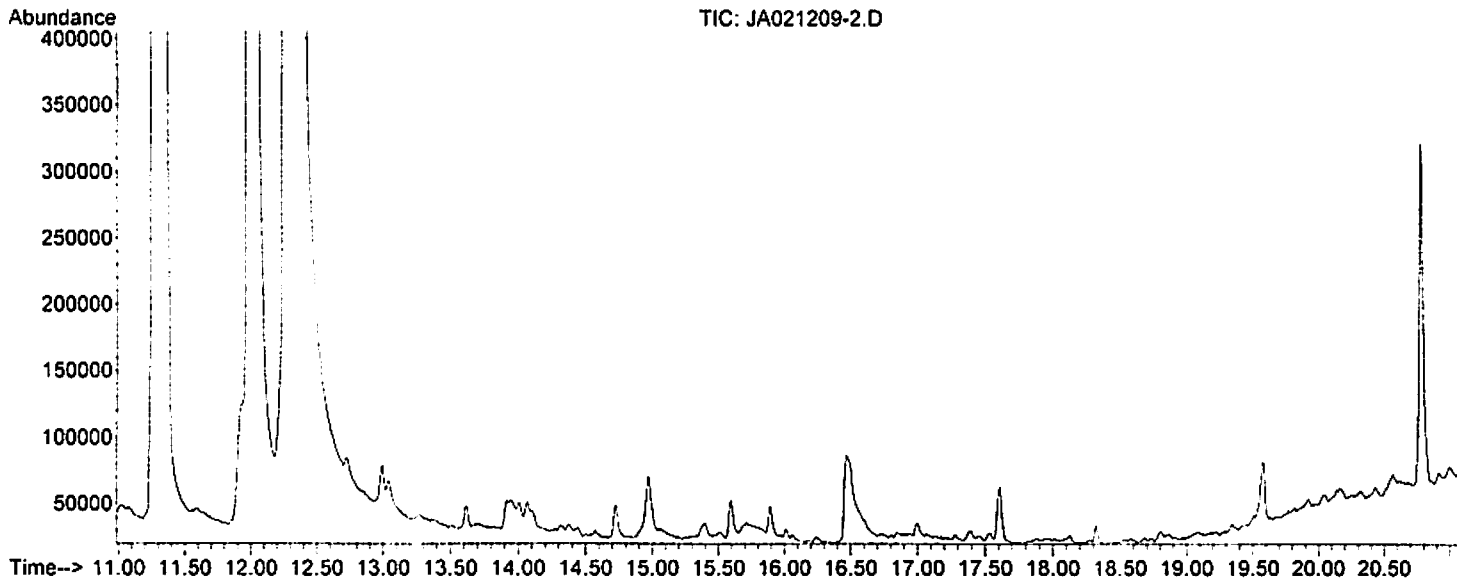

File : D:\DATA\Aldrich\JA-09\JA021209-2.D
Operator : Aldrich
Acquired : 12 Feb 2009 15:15 using AcqMethod JA-WAX08.M
Instrument : 12 Instrument #1
Sample Name: 7 14-22-d-old male C.oc. abd. /5ULCH2C12
Misc Info : larvae reared on aphids; different appearance
Vial Number: 1

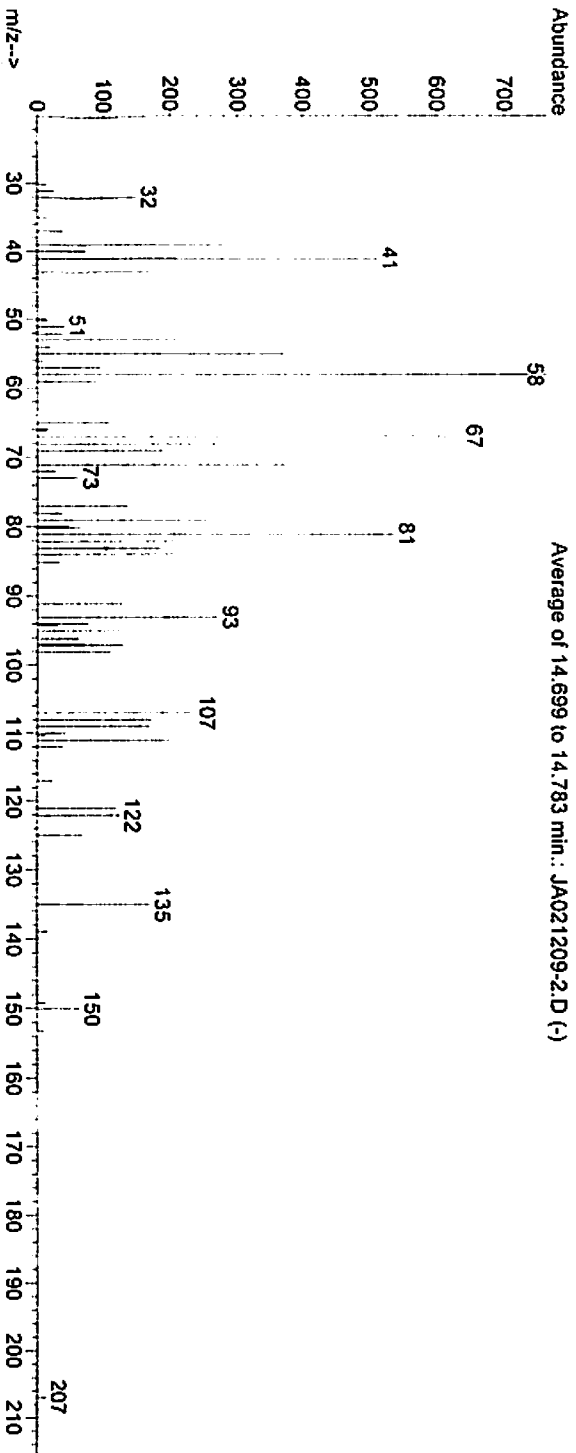
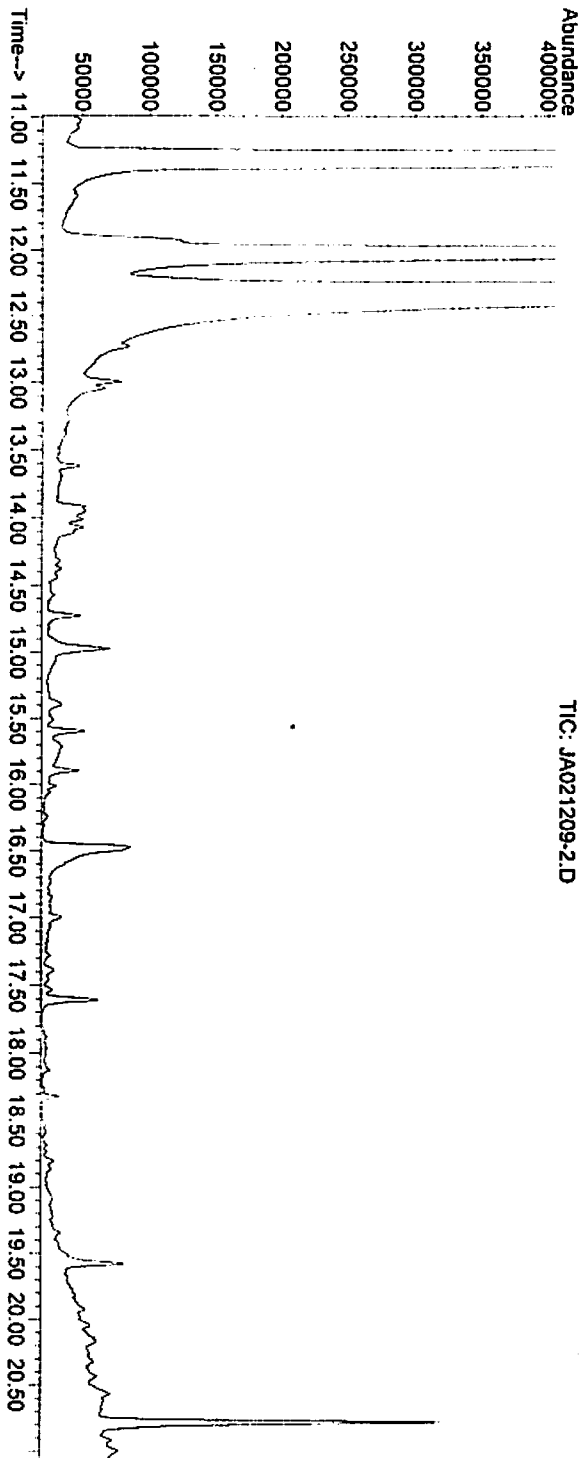

File : D:\DATA\Aldrich\JA-09\JA021209-2.D
Operator : Aldrich
Acquired : 12 Feb 2009 15:15 using AcqMethod JA-WAX08.M
Instrument : Instrument #1
Sample Name: 7 14-22-d-old male C.oc. abd. /5ulCH2Cl2
Misc Info : larvae reared on aphids; different appearance
Vial Number: 1

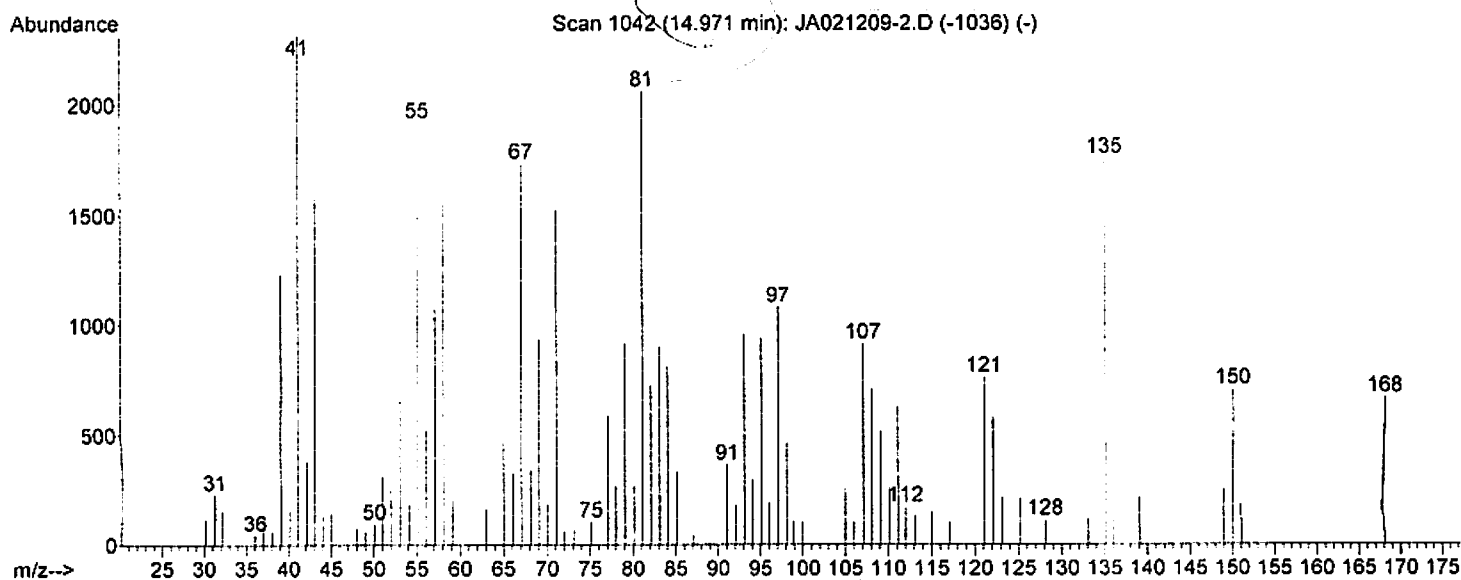
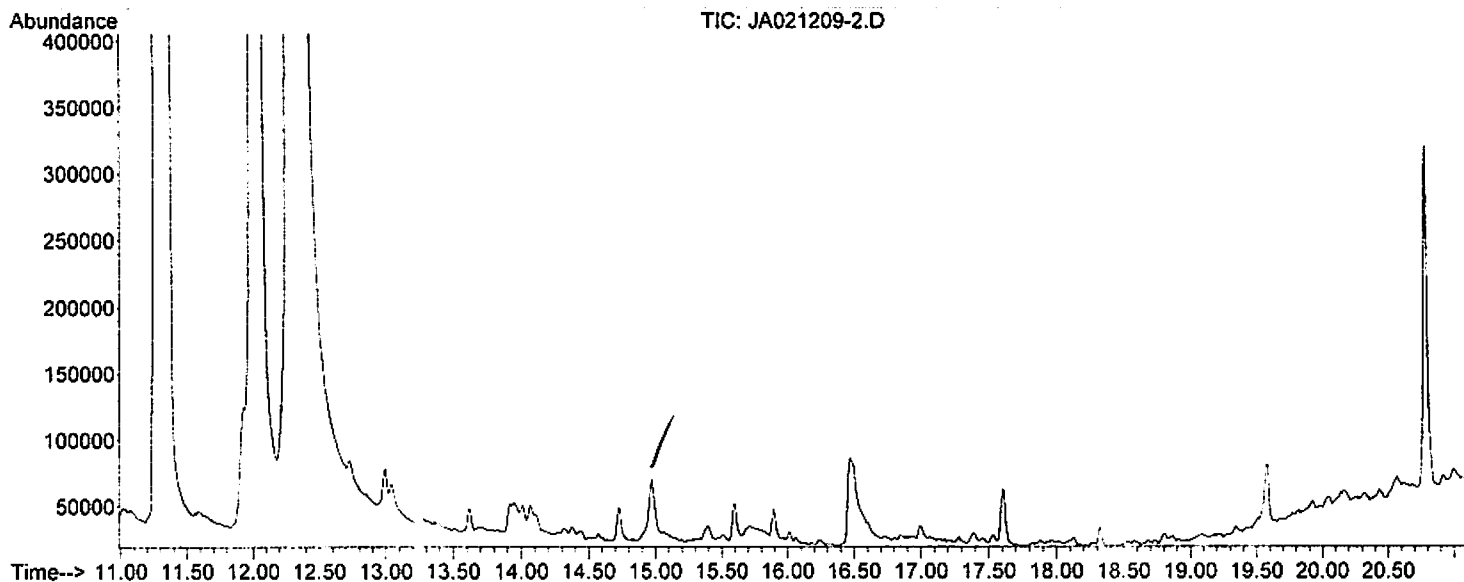

File : D:\DATA\Aldrich\JA-09\JA021209-2.D
Operator : Aldrich
Acquired : 12 Feb 2009 15:15 using AcqMethod JA-WAX08.M
Instrument : Instrument #1
Sample Name: 7 14-22-d-old male C.oc. abd. /SulCH2C12
Misc Info : larvae reared on aphids; different appearance
Vial Number: 1

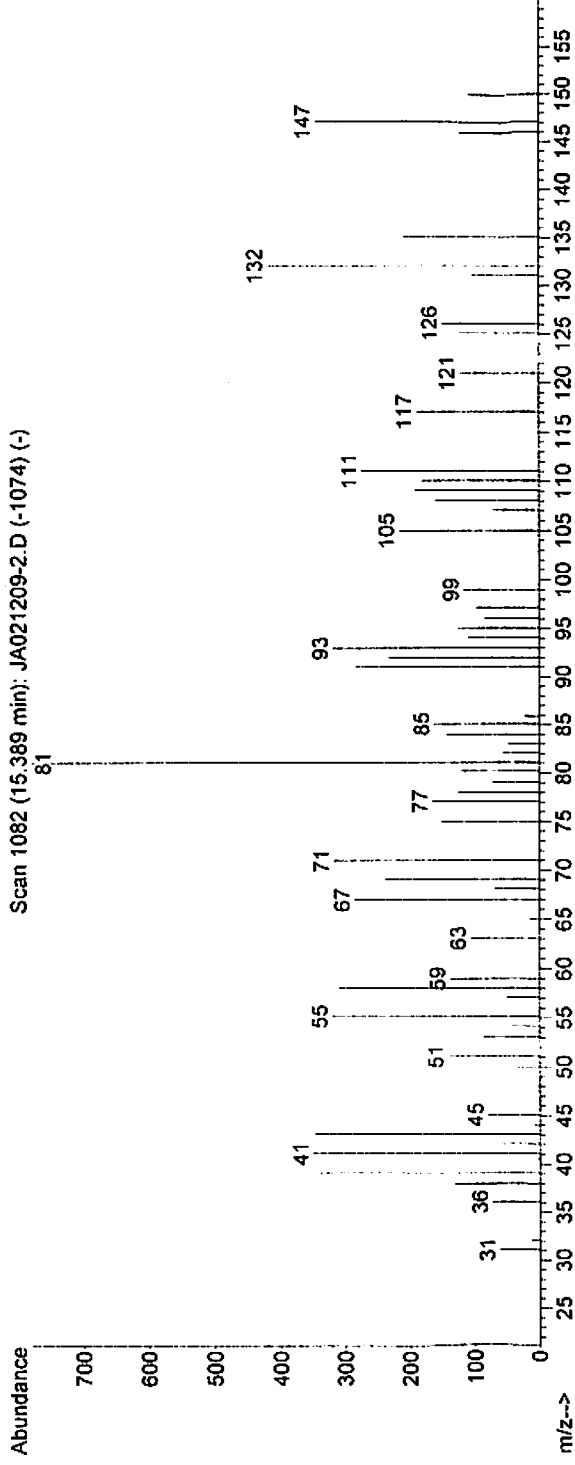
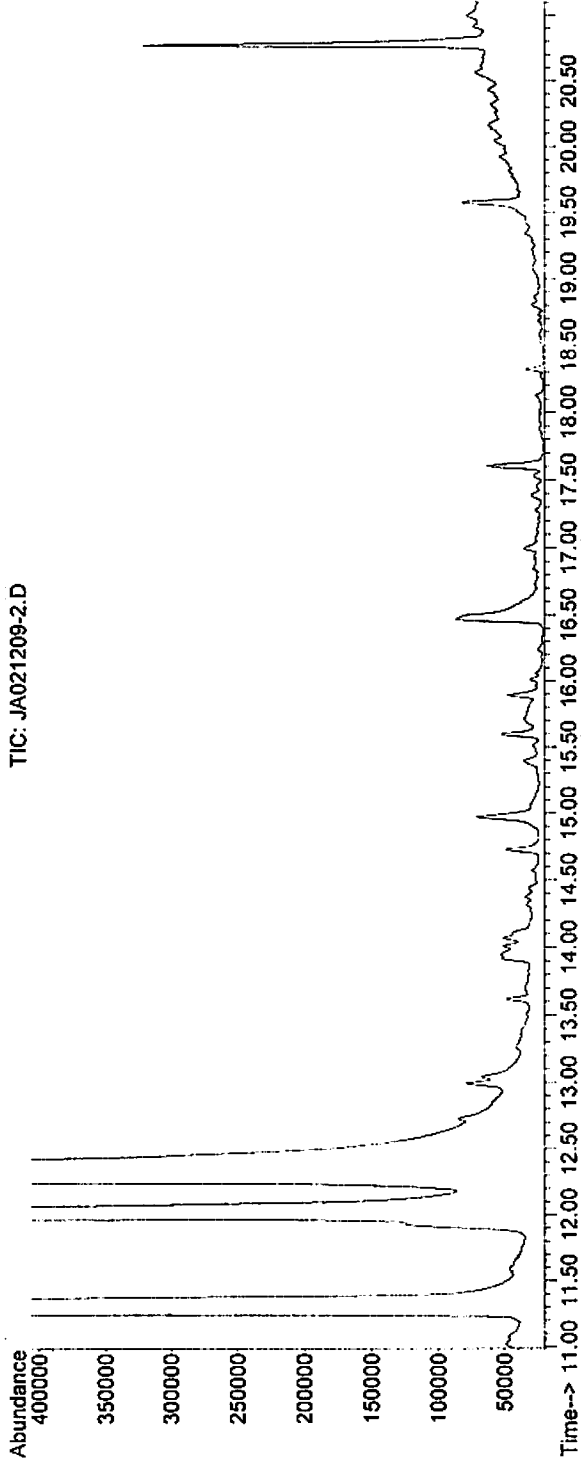

File : D:\DATA\Aldrich\JA-09\JA021209-2.D
Operator : Aldrich
Acquired : 12 Feb 2009 15:15 using AcqMethod JA-WAX08.M
Instrument : Instrument #1
Sample Name: 7 14-22-d-old male C.oc. abd. /5ulCH2Cl2
Misc Info : larvae reared on aphids; different appearance
Vial Number: 1

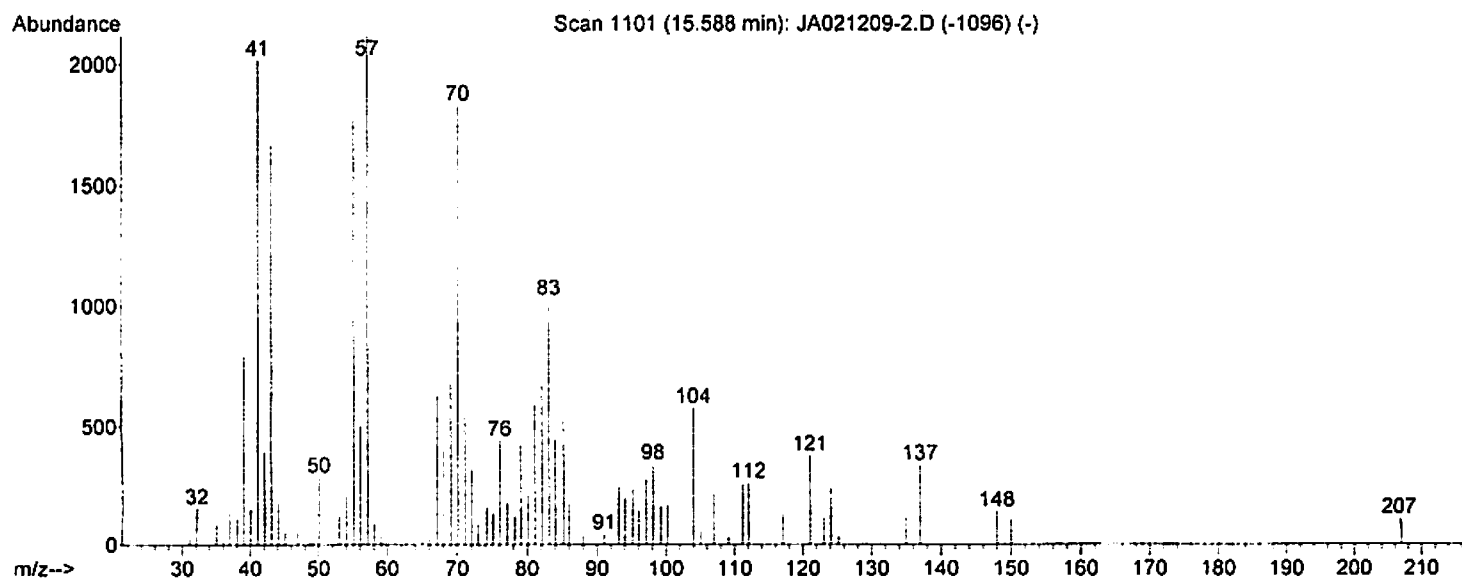
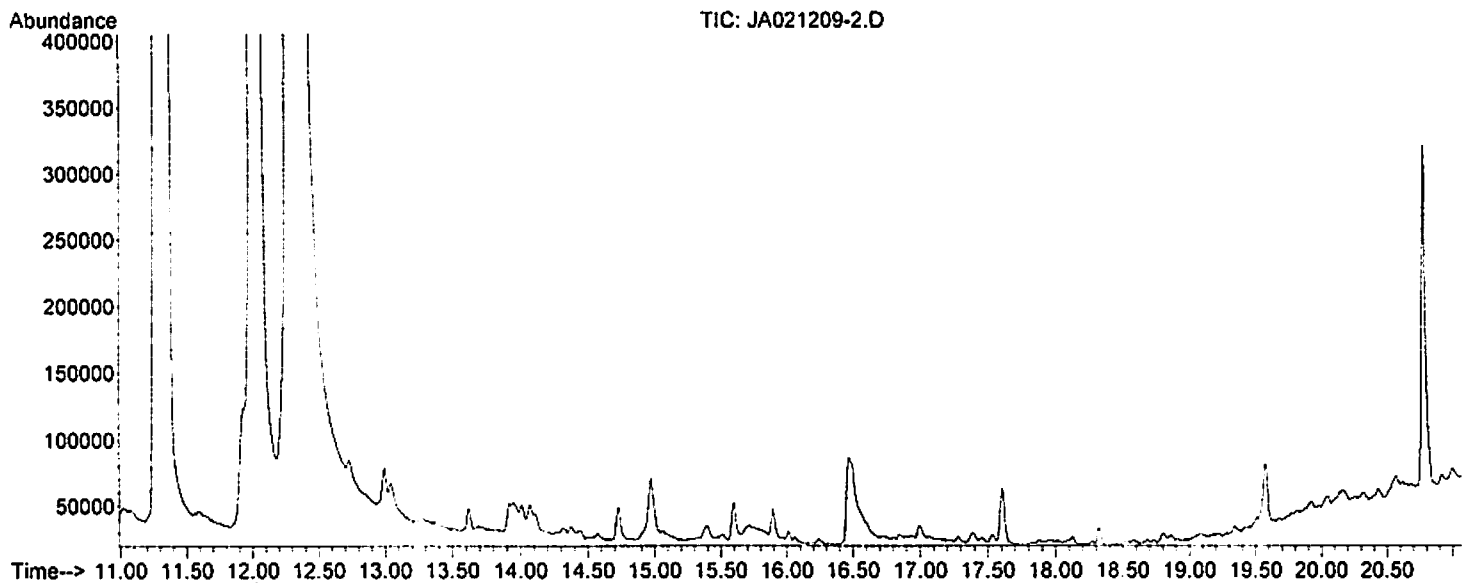

File : D:\DATA\Aldrich\JA-09\JA021209-2.D
Operator : Aldrich
Acquired : 12 Feb 2009 15:15 using AcqMethod JA-WAX08.M
Instrument : Instrument #1
Sample Name: 7 14-22-d-old male C.oc. abd. /5ulCH2Cl2
Misc Info : larvae reared on aphids; different appearance
Vial Number: 1

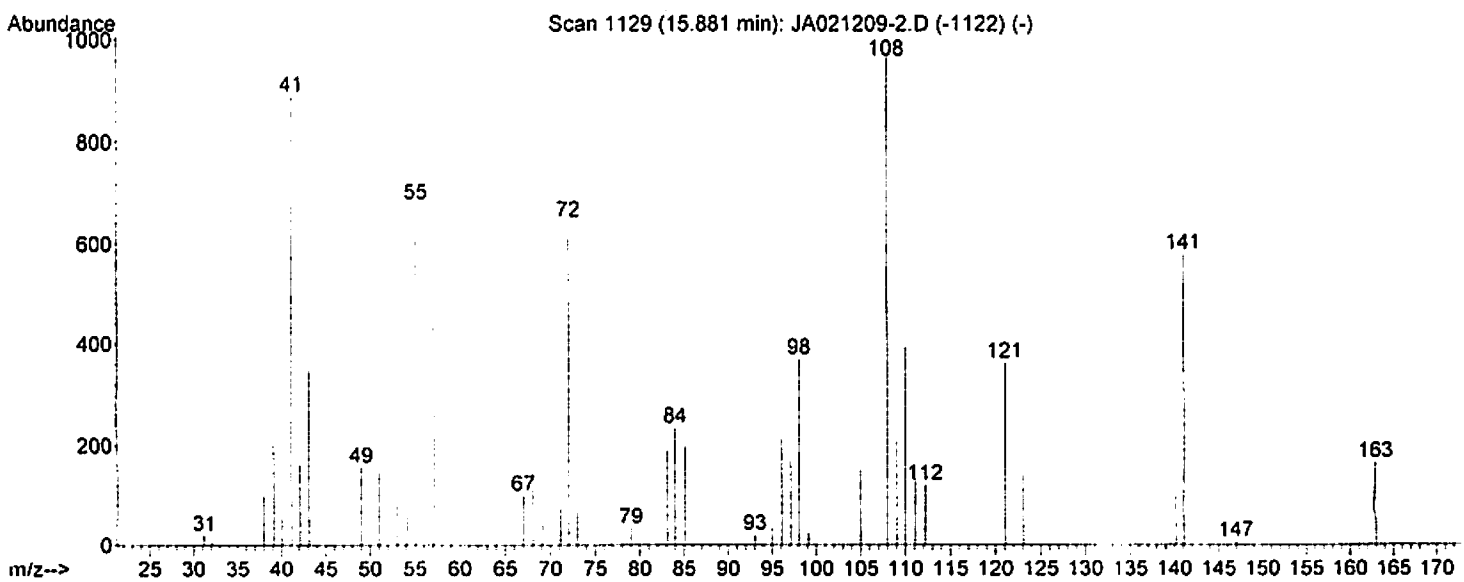
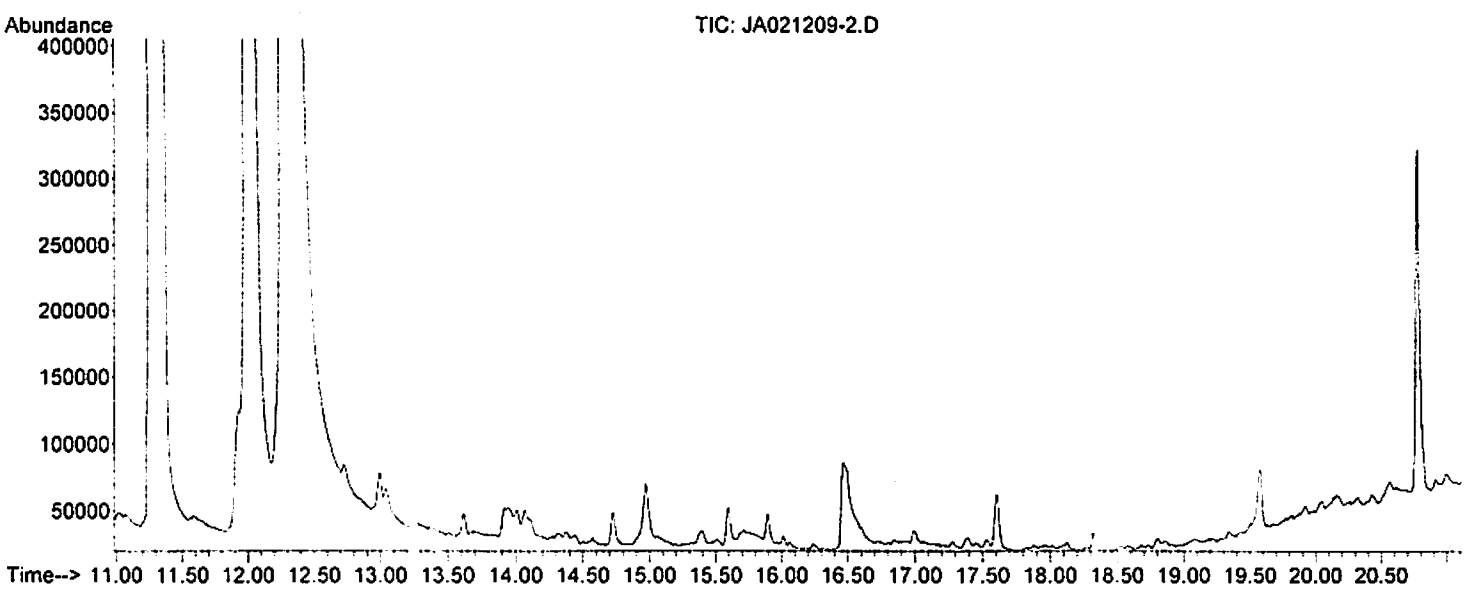

File : D:\DATA\Aldrich\JA-09\JA021209-2.D
Operator : Aldrich
Acquired : 12 Feb 2009 15:15 using AcqMethod JA-WAX08.M
Instrument : Instrument #1
Sample Name: 7 14-22-d-old male C.oc. abd. /5ulCH2Cl2
Misc Info : larvae reared on aphids; different appearance
Vial Number: 1

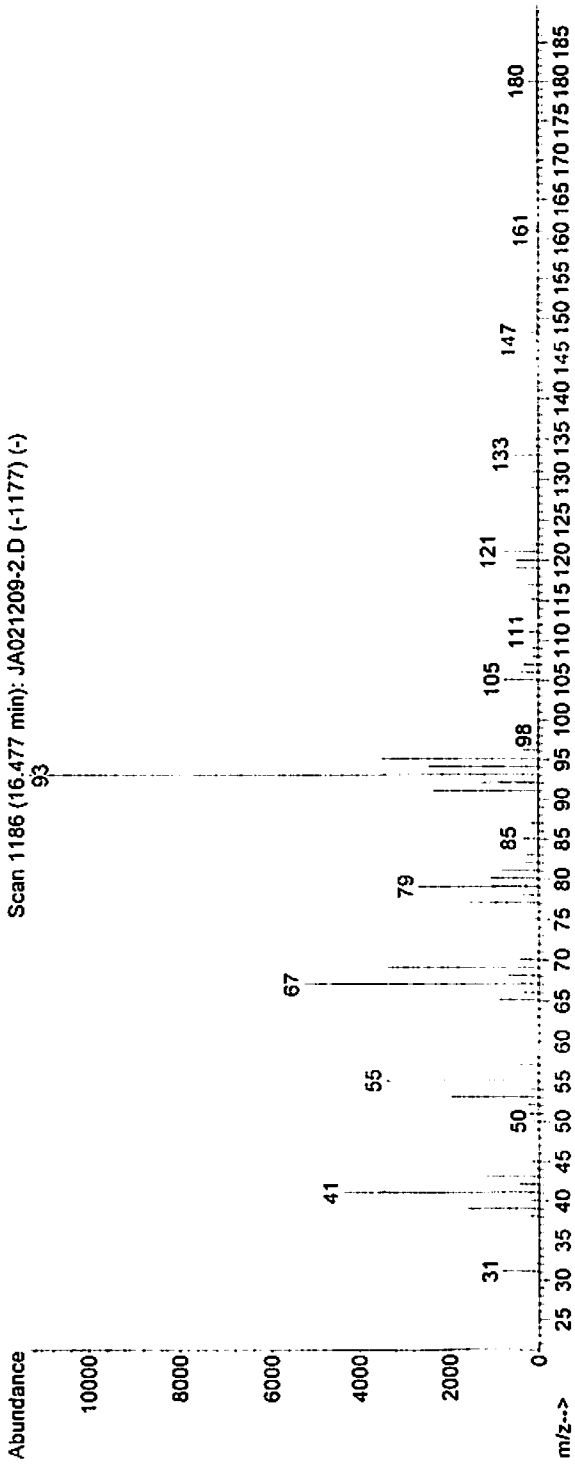
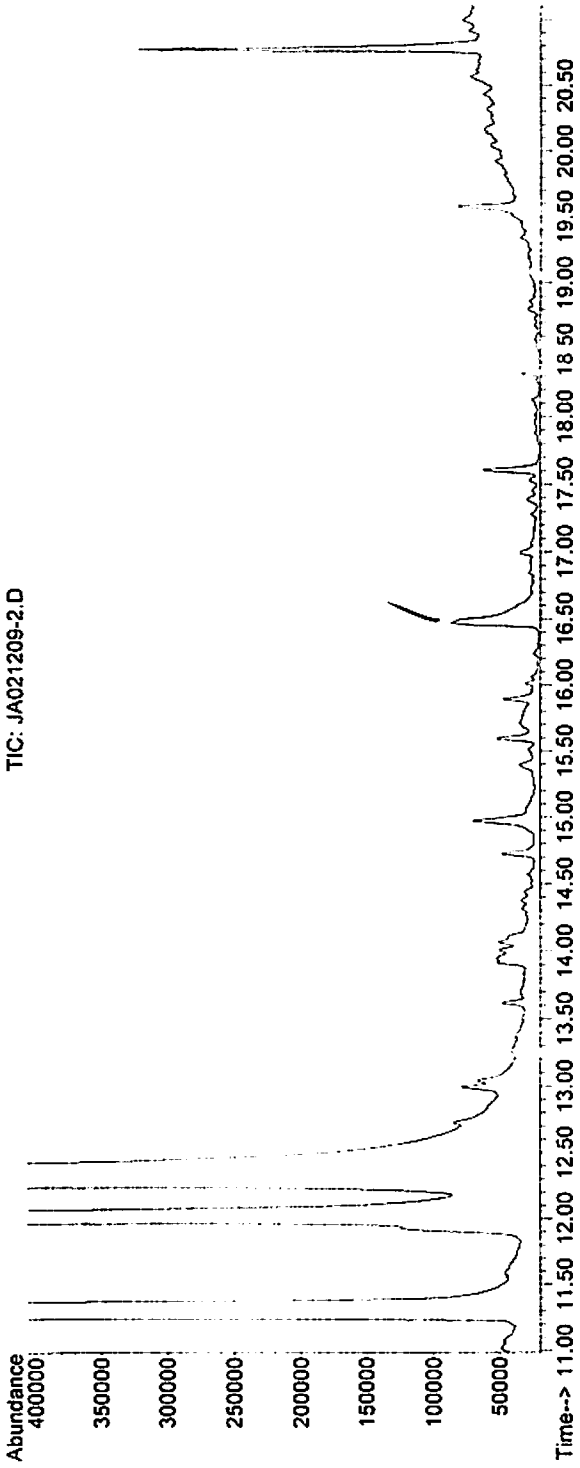

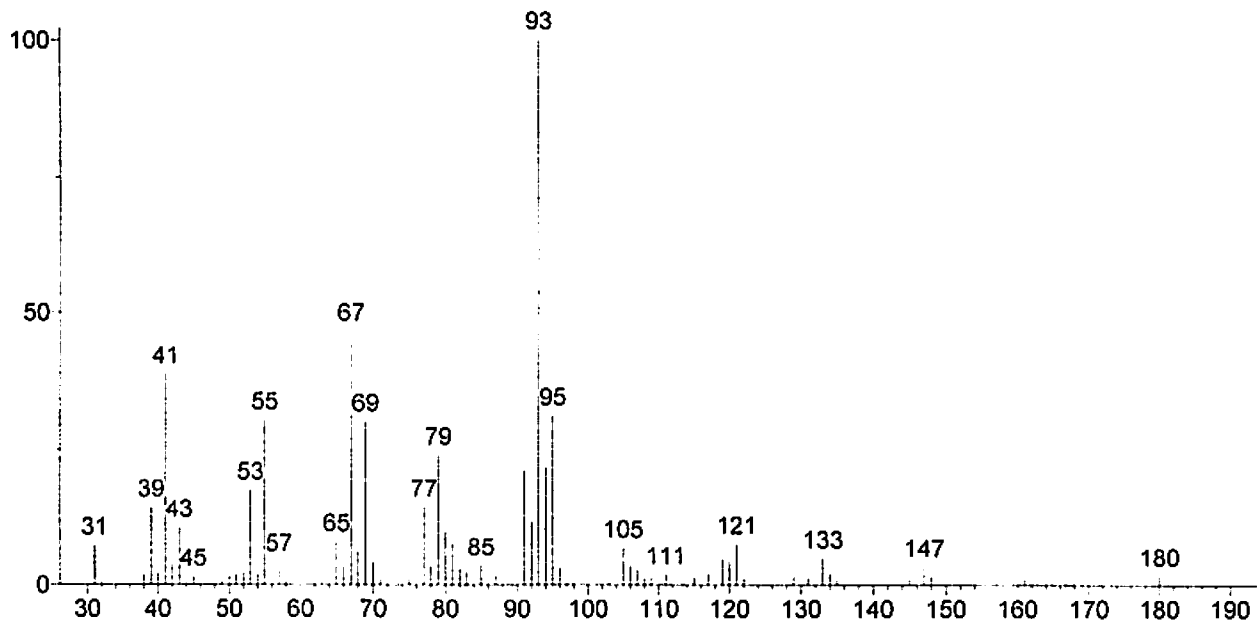

(Text File) Scan 1186 (16.477 min): JA021209-2.D (-1177)

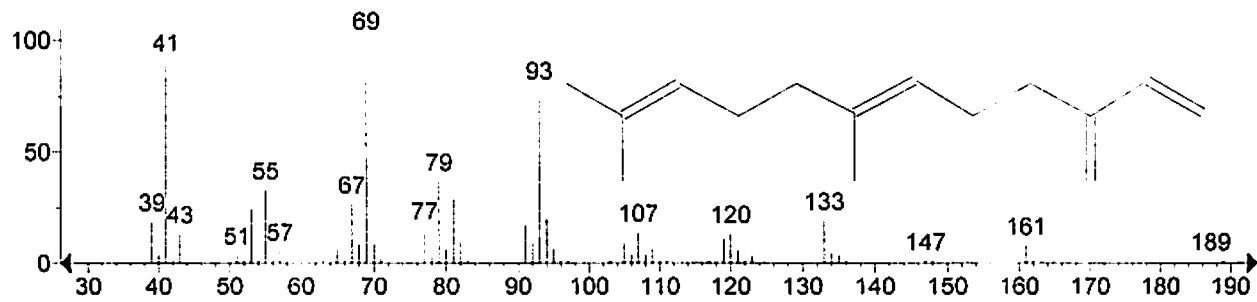
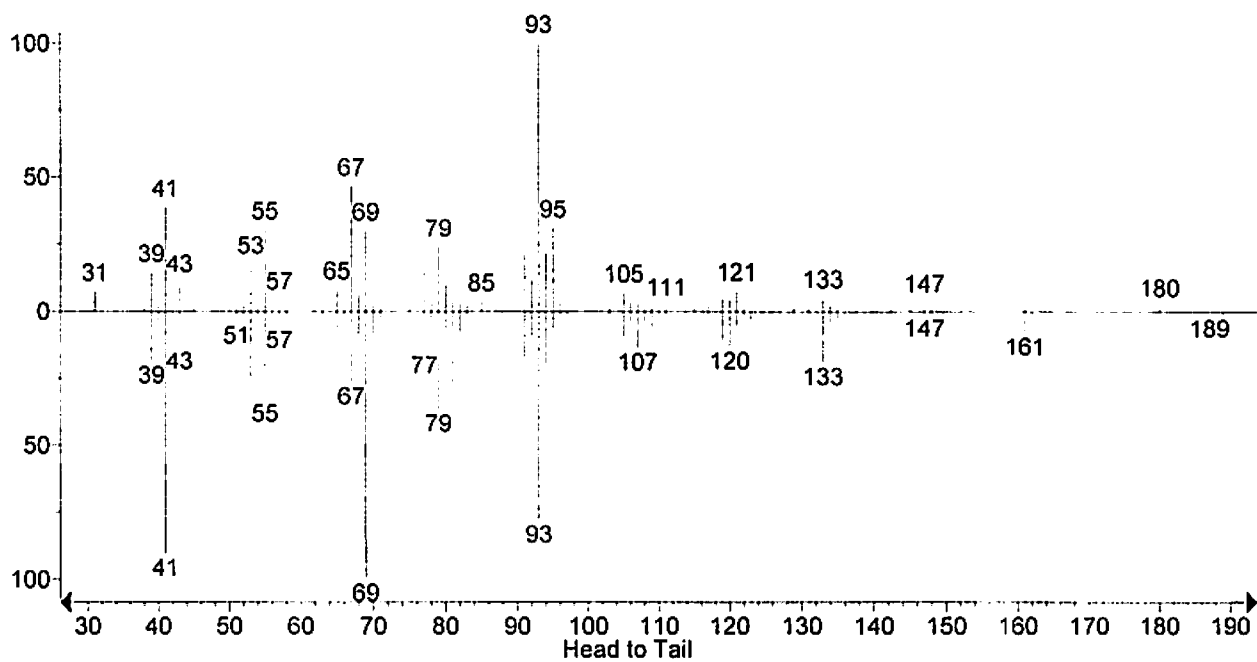

(replib) 1,6,10-Dodecatriene, 7,11-dimethyl-3-methylene-, (E)-

File : D:\DATA\Aldrich\JA-09\JA021209-2.D
Operator : Aldrich
Acquired : 12 Feb 2009 15:15 using AcqMethod JA-WAX08.M
Instrument : Instrument #1
Sample Name: 7 14-22-d-old male C.oc. abd. /5ulCH2Cl2
Misc Info : larvae reared on aphids; different appearance
Vial Number: 1

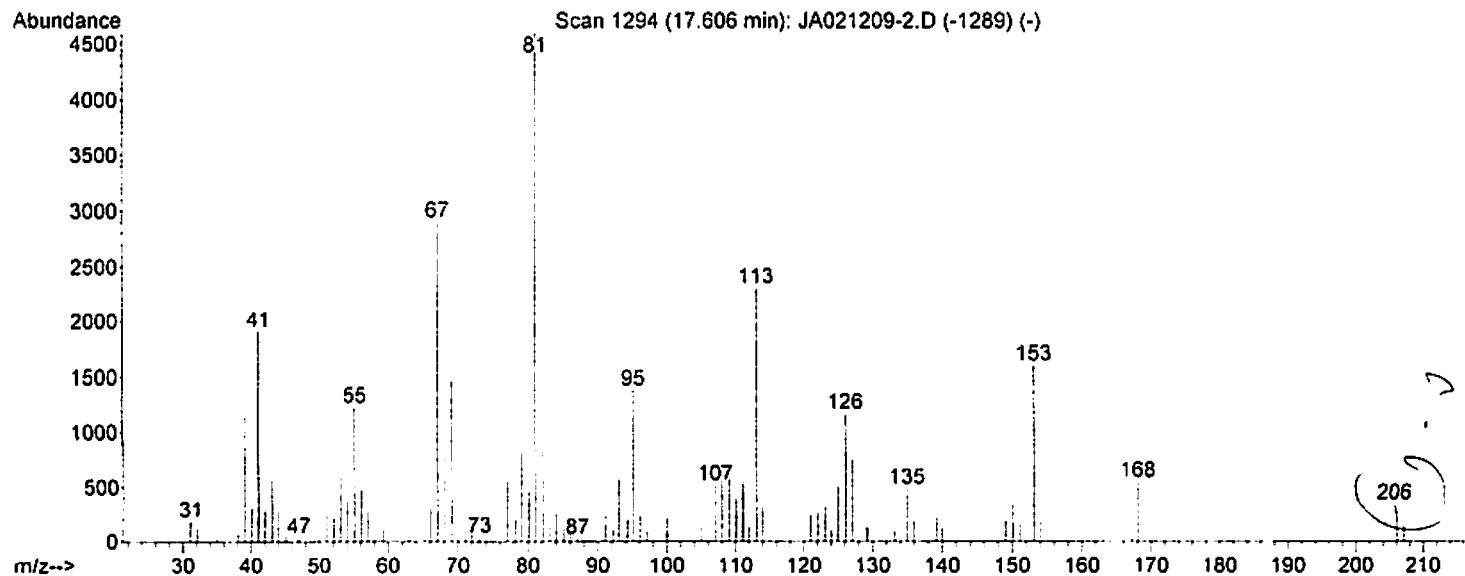
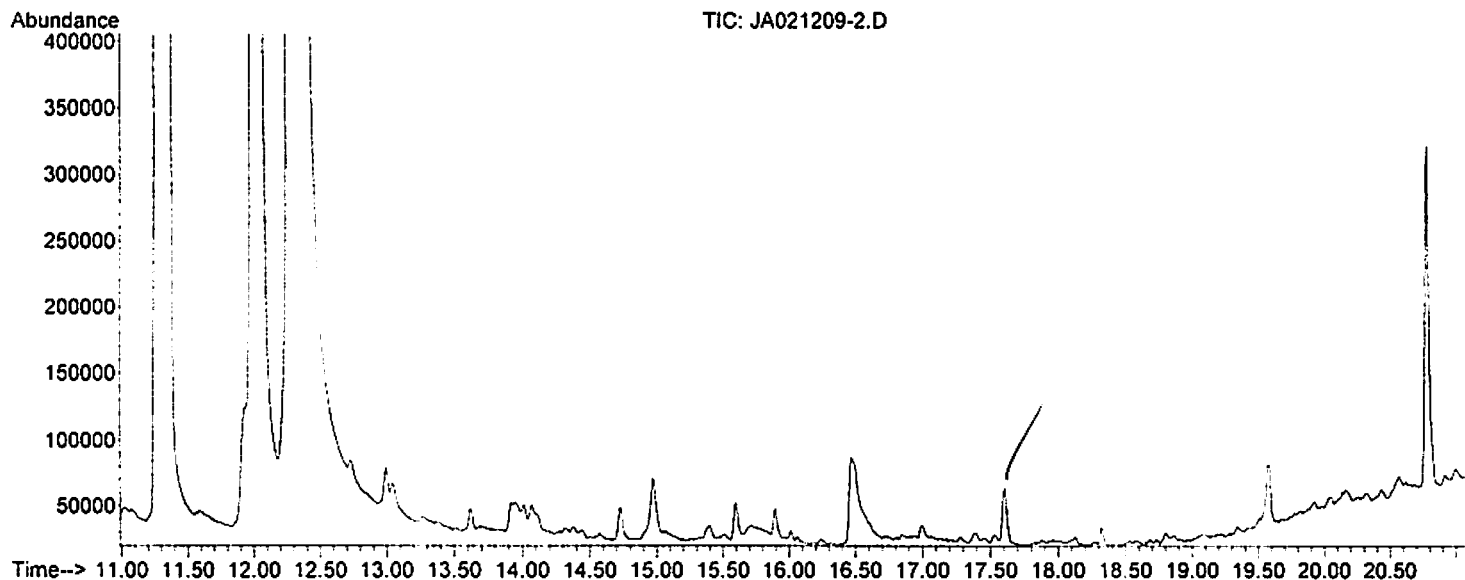

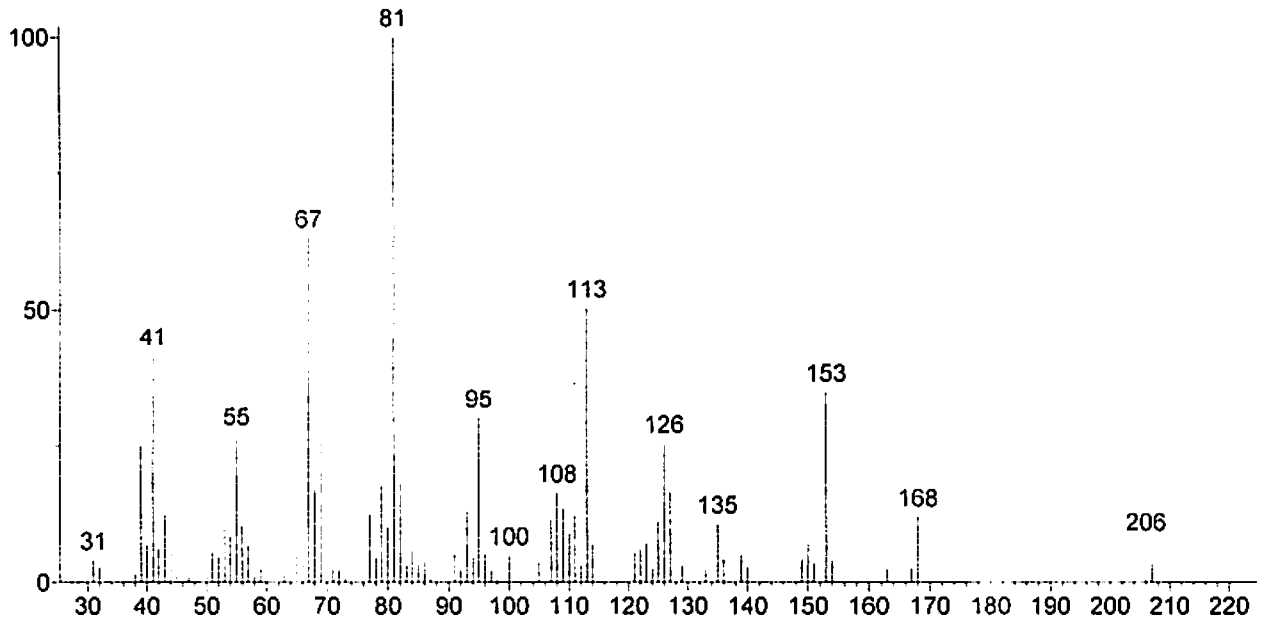

(Text File) Scan 1294 (17.606 min): JA021209-2.D (-1289)

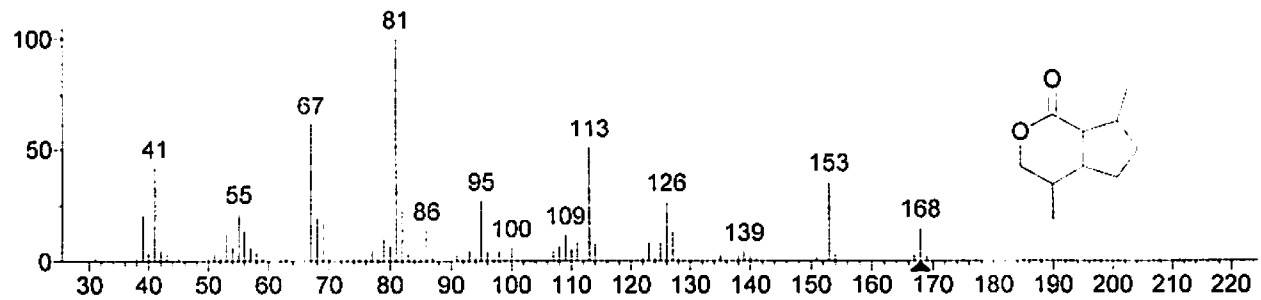
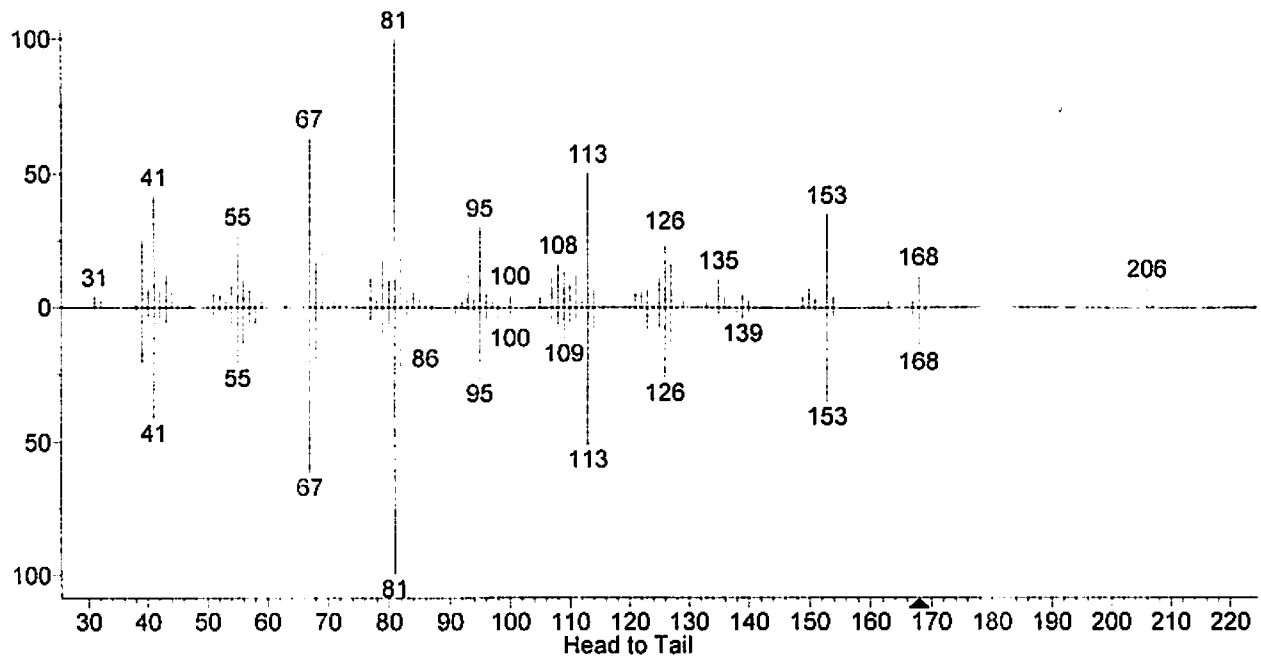

(mainlib) Cyclopenta[c]pyran-1(3H)-one, hexahydro-4,7-dimethyl-, (4.alpha.,4a.alpha.,7.alpha.,7a.alpha.)-

File : D:\DATA\Aldrich\JA-09\JA021209-2.D
Operator : Aldrich
Acquired : 12 Feb 2009 15:15 using AcqMethod JA-WAX08.M
Instrument : Instrument #1
Sample Name: 7 14-22-d-old male C.oc. abd. /5ulCH2Cl2
Misc Info : larvae reared on aphids; different appearance
Vial Number: 1

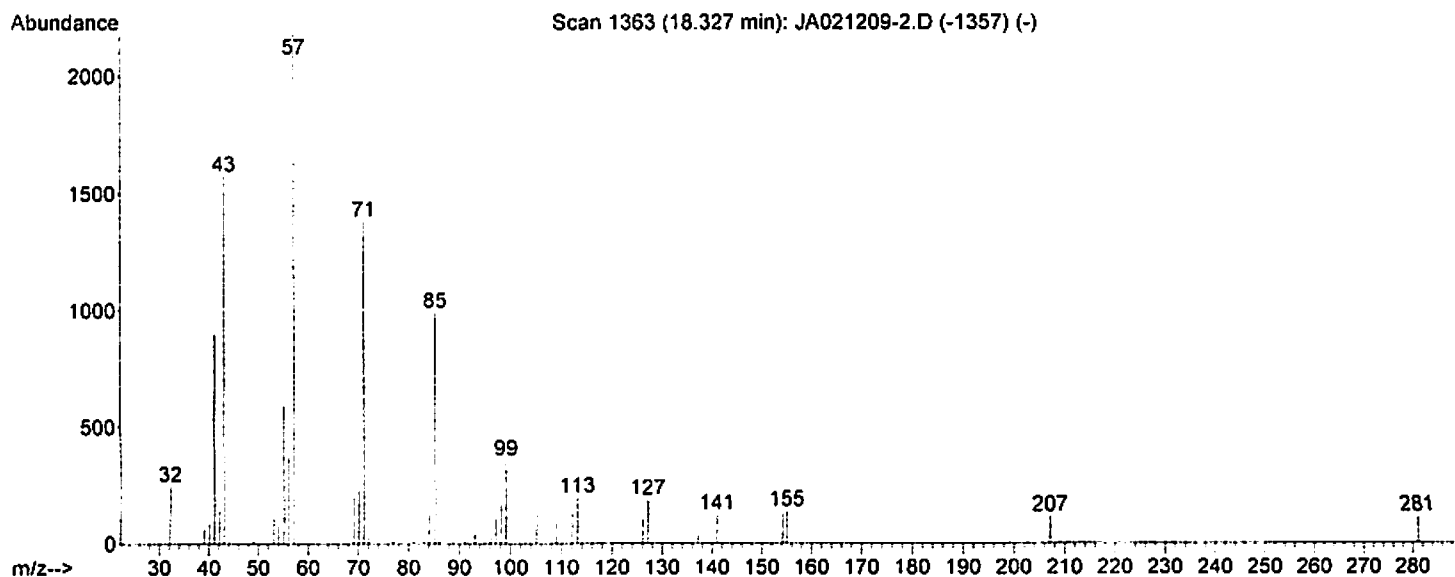
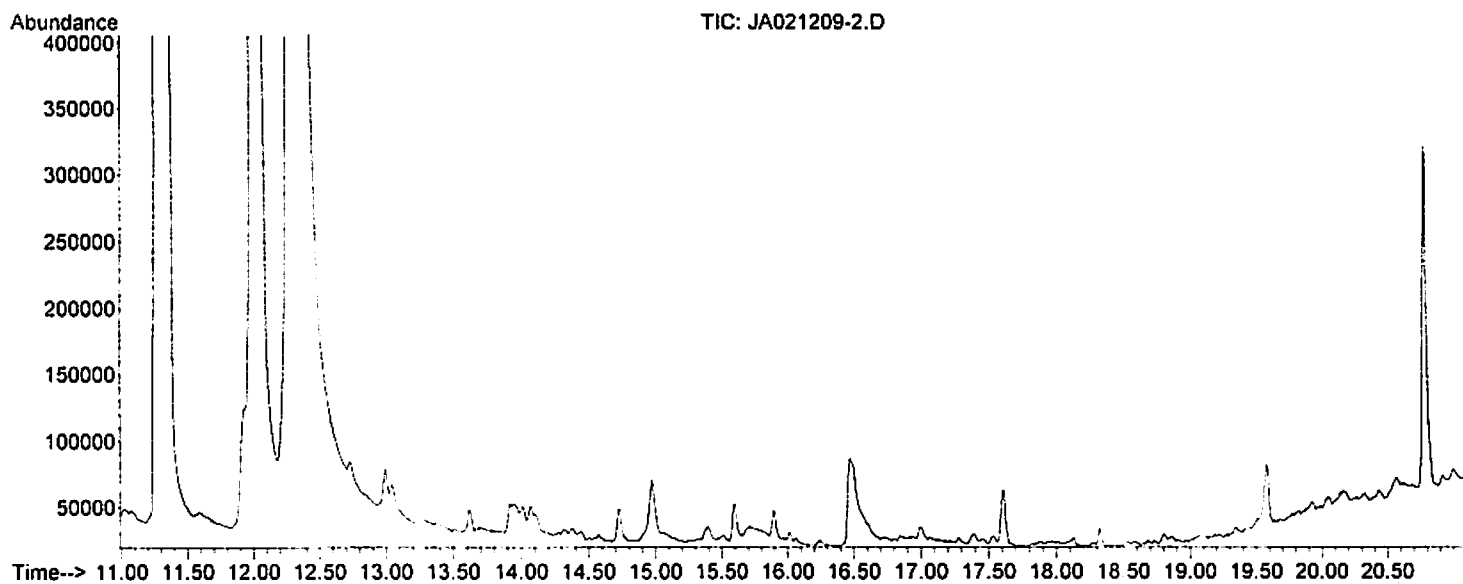

file : D:\DATA\Aldrich\JA-09\JA021209-2.D
Operator : Aldrich
Acquired : 12 Feb 2009 15:15 using AcqMethod JA-WAX08.M
Instrument : Instrument #1
Sample Name: 7 14-22-d-old male C.oc. abd. /5ulCH2Cl2
Misc Info : larvae reared on aphids; different appearance
Vial Number: 1

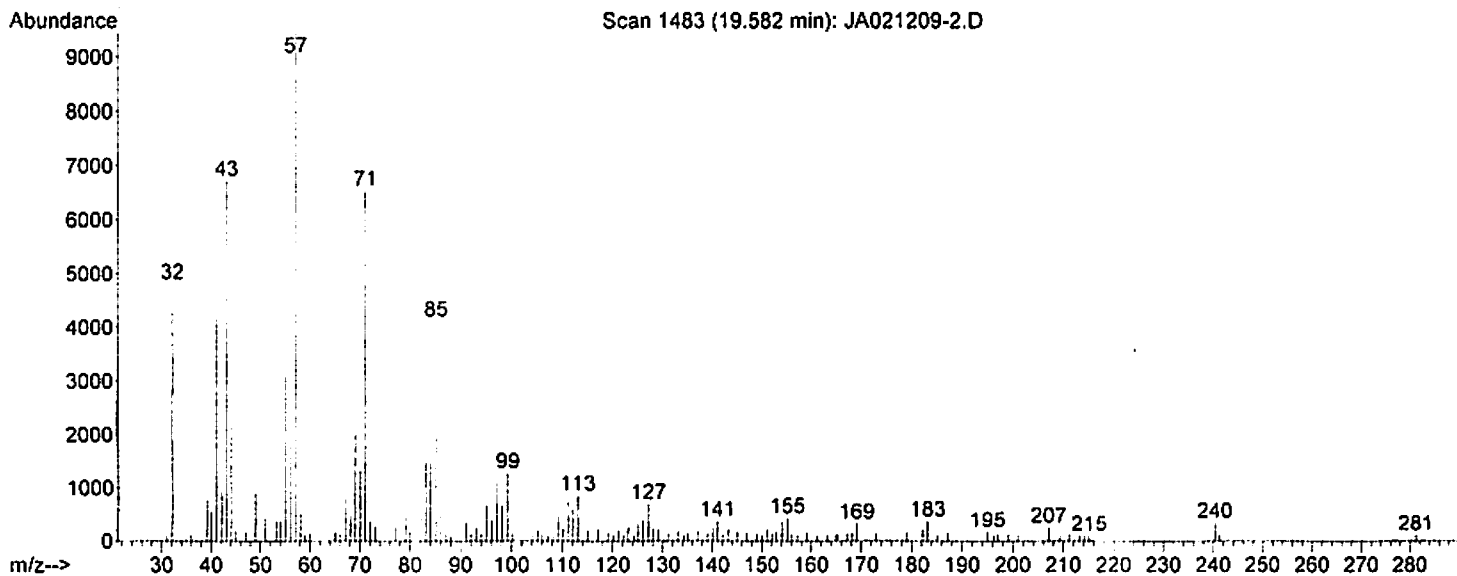
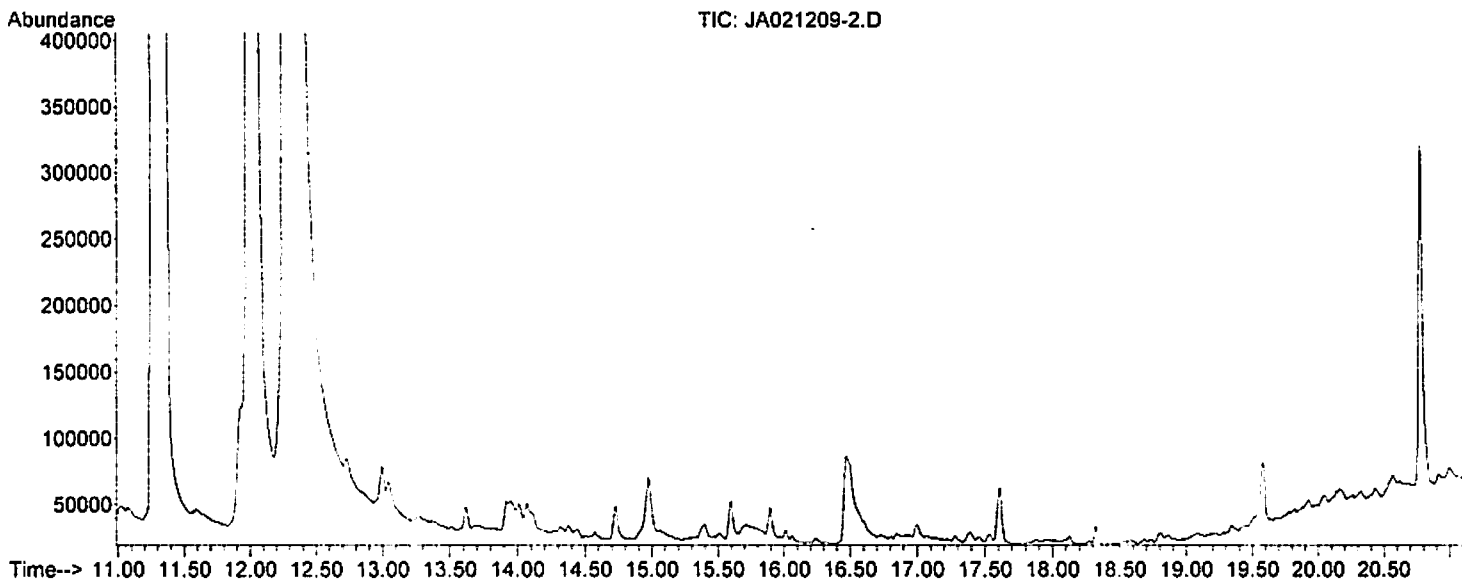

File : D:\DATA\Aldrich\JA-09\JA021209-2.D
Operator : Aldrich
Acquired : 12 Feb 2009 15:15 using AcqMethod JA-WAX08.M
Instrument : Instrument #1
Sample Name: 7 14-22-d-old male C.oc. abd. /5ulCH2Cl2
Misc Info : larvae reared on aphids; different appearance
Vial Number: 1

